

---

**CATALINA 300 MPC  
INSTALLATION & OWNER'S  
MANUAL**

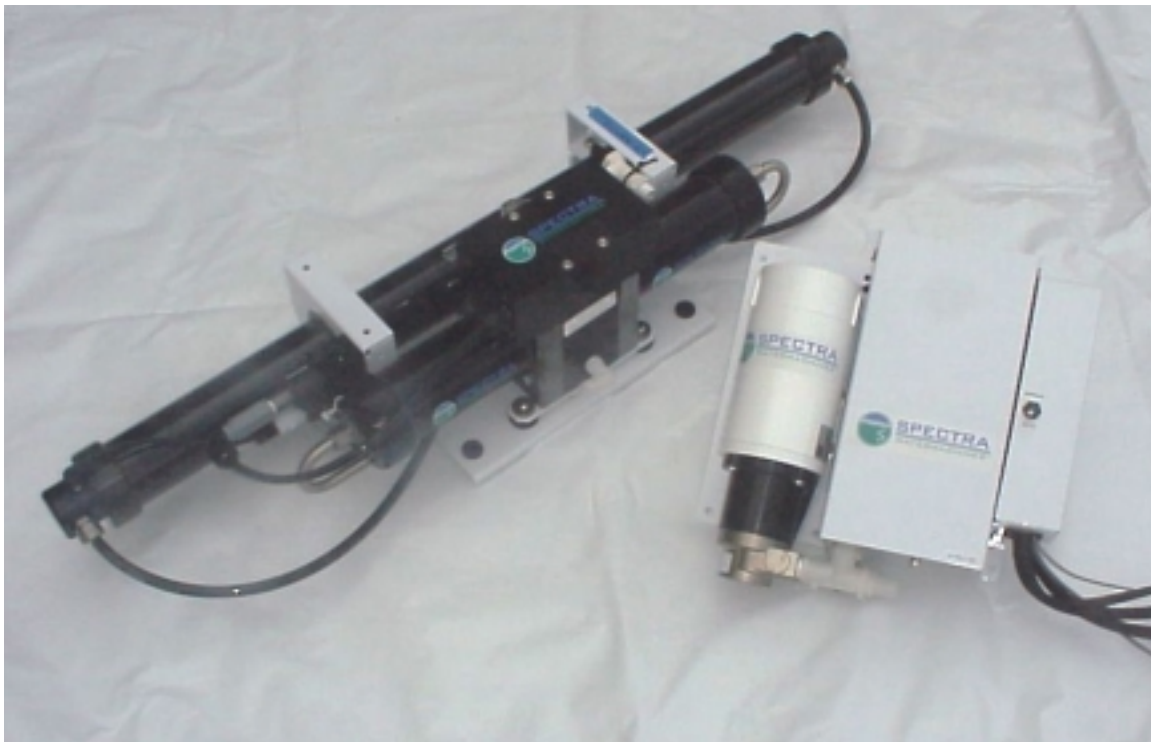

**Spectra Watermakers, Inc.  
20 Mariposa Road, San Rafael, CA 94901  
Phone 415-526-2780 Fax 415-526-2787  
E-mail: [spectra@spectrawatermakers.com](mailto:spectra@spectrawatermakers.com)  
[www.spectrawatermakers.com](http://www.spectrawatermakers.com)  
9/21/05 Rotoflow**



**Thank you** for your purchase of a Spectra Catalina system. Properly installed, it will provide years of trouble-free service. Please pay attention to the installation instructions and the system layout. Like any piece of mechanical equipment, the system will require inspection and service from time to time. Do not place the components in inaccessible areas that will prevent proper maintenance. If you are having a dealer install the system for you, review the location of the components to make sure that the installation will meet your approval upon completion.

## Catalina Installation Quick Start

### Important Details for Installer

1. The system must have a dedicated sea water inlet to guarantee a solid flow of water to the system. The inlet should be as low in the boat as possible and with a scoop type forward facing thru-hull fitting installed.
2. Both the Catalina Mag Drive feed pump module and the Clark Pump/membrane module must be installed in a well-ventilated compartment where **temperatures will not exceed 120°F (48°C)**. Many engine compartments exceed this temperature when underway. Warranty will be void if the installation does not meet this requirement.
3. Follow the wire gauge charts in the instructions. Using larger wire than specified is acceptable.
4. The MPC control must have continuous DC power to achieve the full benefits of the fresh water flush system. The domestic fresh water pressure must be on and the fresh water tank level maintained. Calculate 3 gallons (12L) per flush..
5. The MPC 3000 control must be de-powered (DC power off) after the system is put in storage and “pickled”, when a storage chemical or antifreeze is run through the system.
6. If you are separating the Clark Pump/membrane assembly, please review the high pressure tube assembly instructions. Improper assembly will cause failure!
7. Run test, then “sea trial” the complete system before assuming the system is operational. If the boat is in fresh or dirty water, see “Dry Testing the System.”
8. Spectra dealers are responsible for educating the vessel owners on the operation and maintenance of the system. We request that you “walk through” the installation with our customer.
9. Please have the owner fill out the warranty card. The warranty is void if it is not registered.



# Table of Contents

## **Installation**

## **Page Number**

Getting Started .....	7
Catalina Schematic .....	8
Installation Basics .....	9
Component Placement .....	10
Plumbing .....	13
Parker Tube Fitting Assembly Procedure .....	16
Membrane Pressure Vessel Relocation.....	17
Wiring .....	19
MPC Tank Switch Wiring and operation.....	25
Wiring Diagram .....	26
Z Brane Installation .....	53

## **Operation**

New Systems Start Up and Testing .....	27
Dry Testing .....	30
Normal Start Up Using the Auto Run.....	31
Automatic Fresh Water Flush Cycle.....	32
Manual Operation .....	33
Maintenance.....	38
Bulletins.....	45

## **Service & Maintenance**

Long Term Storage Procedures .....	34
Winterizing .....	37
Membrane Cleaning.....	39
Salinity Probe Calibration.....	41
Suggested Spares .....	42
Catalina Troubleshooting Procedures, Service Bulletins .....	43
Parts breakdown for all Catalina Magdrive systems.....	56



## Getting Started

Unpack the system and inspect it to make sure that it has not been damaged in shipment.

Refer to the shipping list for your system to make sure you have received all of the components listed. Do not discard any packaging until you have found and identified all of the parts. The small installation parts are listed on the cellophane bags' pick list.

***We will not be held responsible for shortages and/or freight damage that are not reported within thirty days of the ship date.***

Next, study the system layout diagram, component photos, and descriptions before beginning your installation. This will assist you in understanding the function of each component.

Layout the system. Before starting the installation, identify the location where each module and component will be placed. Insure that there is proper clearance around the components for removal of filters and system service. Also check to make sure you have adequate tubing and hose before starting so additional parts may be ordered. Check to see that the MPC cable is long enough to reach from the display location to the main module.

Catalina Mag Drive shipping list:

- Catalina MPC Magnetic Drive Feed Pump Module
- High Pressure Clark Pump and Reverse Osmosis Membrane Module
- Fresh Water Flush Module
- Dual Filter Assembly
- Catalina Installation Kit
- Accumulator / Gauge Assembly
- Service Hose Kit
- 5/8" Hose (25')
- 3/4" Suction Hose (25')

# CATALINA 300 MPC SCHEMATIC

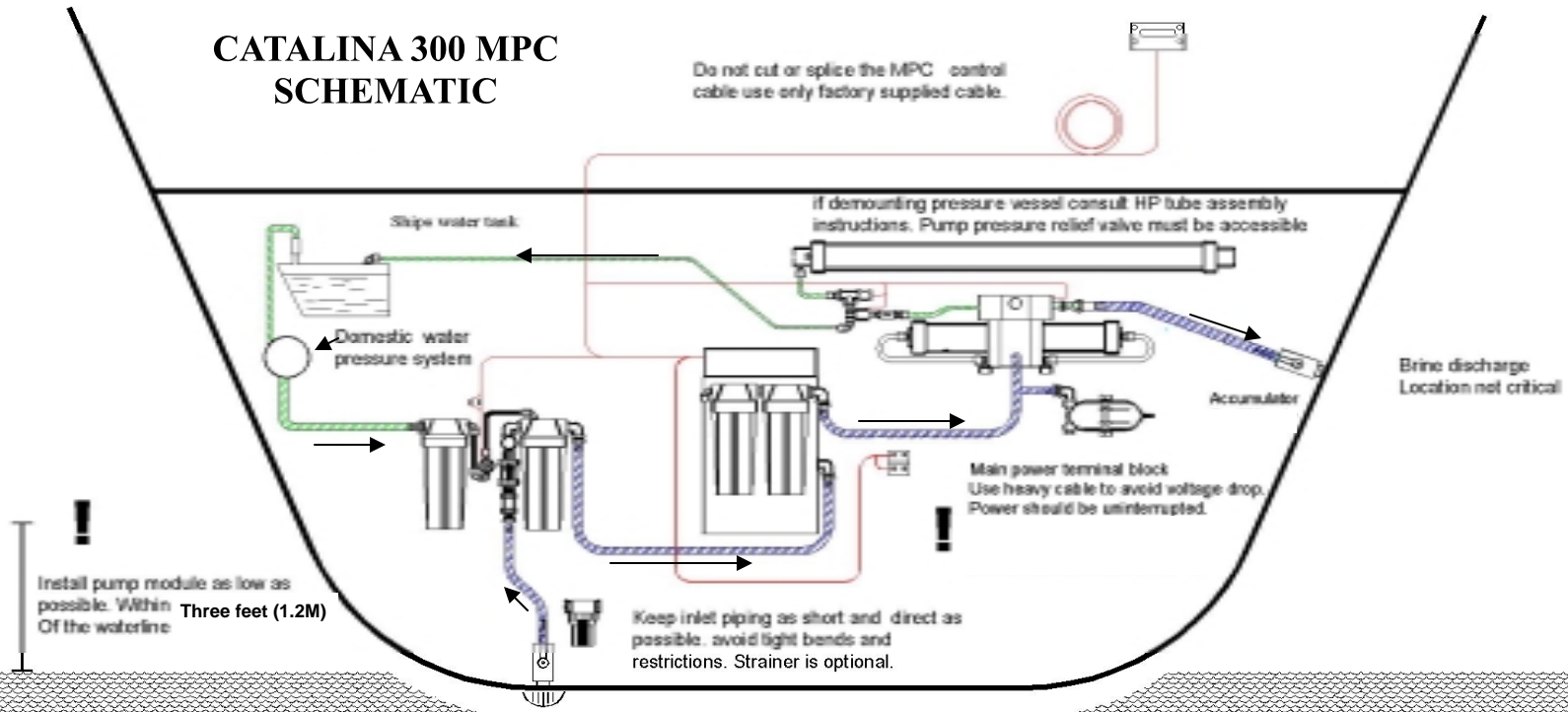

! Install pump module as low as possible. Within Three feet (1.2M) Of the waterline

! Install a dedicated 3/4" thru hull with a scoop type strainer . Place the inlet a low as possible with scoop facing forward. Avoid turbulent areas

## Installation Basics

- **Read the directions!**
- Avoid tight hose bends and excessive runs.
- Use heavy gauge wire.
- Install feed pump as low as possible.
- Use a dedicated thru-hull with scoop-type strainer.

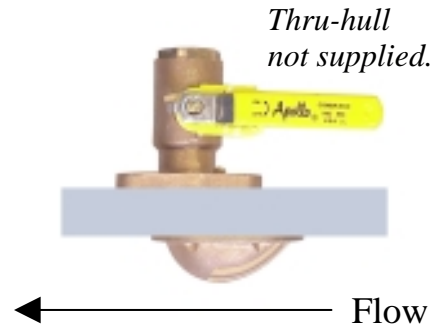

*Thru-hull  
not supplied.*

### Thru-hulls

It is mandatory that a dedicated  $\frac{3}{4}$ " to 1" forward facing scoop-type intake thru-hull and sea-cock be installed. Install the intake for the system close to the middle and as far below the water line as possible. Thru-hulls in the bow area are susceptible to air intake in rough conditions. Sharing a thru-hull with another system is not acceptable and will void the warranty. Sharing a thru-hull can introduce unforeseen problems such as intermittent flow restriction, air bubbles, and contaminates. For racing boats and high speed power boats above 15 knots a retractable snorkel-type thru-hull fitting is preferred to be able to pick up water away from the hull.

Do not install the intake close to or downstream of a head discharge. Install as far below the waterline and as close to center line as possible to avoid contamination and air induction.

The brine discharge thru-hull should be mounted above the waterline, in or just above the boot stripe to minimize water lift.

Double clamp all hose connections below the waterline.

### Pipe Fitting Instruction

Plastic-to-plastic fittings should have 3 to 4 wraps of Teflon tape and will thread almost all the way in.

**Avoid getting dirt or debris into the piping or hoses during assembly.** A small bit of debris can stop the system! Avoid getting tape over the end of fittings that might get into the system. To insure this does not happen, leave the very first thread uncoated.

Avoid restrictions or long runs on the entire inlet side of the plumbing from the thru-hull to the main feed pump module.

Prevent tight bends and excessive elbows. Any restrictions will hamper system performance. Secure the piping away from moving objects such as engine belts and hatches. Prevent chafe on the tubing as required. Test and inspect all piping and hose clamps after several hours of operation.

### Wiring

- Pay attention to wire size or system performance will be impaired.
- Perform wiring to UL, ABYC, CE or applicable standards.

## Component Placement

*Refer to the Plumbing Diagrams*

### Strainer

Mount the strainer in an accessible area close to the intake thru-hull that can handle water spillage during service. Extra care during assembly must be taken to avoid air leaks from the strainer. Use the supplied “quick block” and wire tie for mounting.



### Fresh Water Flush Module

The fresh water flush module should be located between the intake strainer and the feed pump module and as low as possible in the vessel. It should be mounted with the filter housings vertical and accessible for changing filters. Allow 2” below the filter housing for removal. Do not install over electrical equipment. Remove filter bowls for access to the screw holes in the mounting plate. The unit contains a 50 micron prefilter, charcoal filter for the flush water, flush solenoid and three way intake service valve.



### Optional Z- Brane

The optional Z-Brane water treatment system is permanently installed in the membrane pressure vessels and continuously helps prevent biogrowth and fouling of the membrane system.



### Feed Pump/Main Module

Mount the feed pump/main module on a horizontal or vertical surface that can be up to 3’ (1.0 M) above the waterline. It is preferable to mount as low as possible. Choose a location which will allow access to the manual switch for maintenance procedures. The feed pump will not operate properly at ambient temperatures over 120°F (48°C).

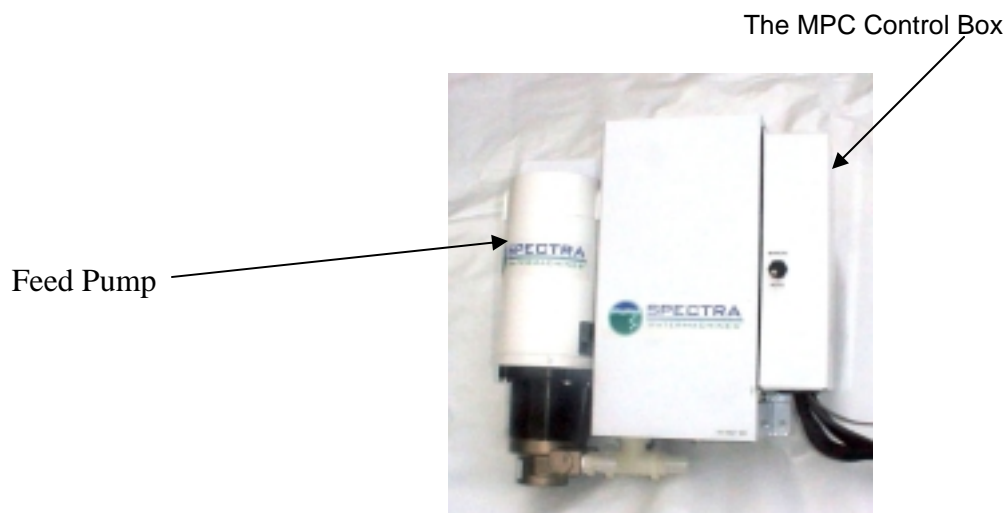

## Clark Pump/Membrane Module



The Clark Pump/membrane module comes complete with a mounting system. Be sure to use the supplied washers on the rubber feet. Use it as a template for drilling the mount holes. Mount in any position but leave access to the pressure relief valve on the Clark Pump. The membrane maximum temperature specification is 120°F. This module must be installed in an area that maintains a temperature below 120°F (50°C). A cool location is preferable. Keep this unit within the 15' (4.5 M) reach of the wires from main feed pump module. This unit may be placed as high in the boat as you desire. Make sure that the area around and under the pump does not have any water sensitive equipment. Water will be spilled during any repairs or if a leak occurs. In order to avoid air bubbles getting trapped on the salinity probe electrodes, the diversion valve/probe assembly must be mounted in a vertical position so that the cable plugs in at the bottom and the electrodes point up.

### Membrane Pressure Vessel Mounting

The Clark pump and membrane assembly has been pre-assembled at the factory. If it is necessary to disassemble this module and mount the pressure vessel remotely use guidelines in back of the manual. Use only approved tubing for assembly.

## Remote Control Panel

The remote control panel can be mounted anywhere that is dry and convenient. Cut a  $4 \frac{9}{16}$ " (116 mm) wide by  $2 \frac{7}{8}$ " (68 mm) high opening for the panel. Locate in an area that is easily visible and easy to manipulate the buttons. **Use only Spectra approved remote cable.**

The cable is not standard LAN cable or phone cord.



## Plumbing

From the inlet thru-hull to the flush module and from the flush module to the pump module inlet, use supplied clear  $\frac{3}{4}$ " (19 mm) spiral suction rated hose. The outlet of the filter assembly on the main module to the Clark Pump assembly is under pressure. Use the supplied braided clear vinyl hose rated to 150 PSI (11 bar). From the Clark Pump brine discharge connector, use supplied  $\frac{5}{8}$ " (15.9 mm) clear braided vinyl hose.

**NOTE: Route all hoses and tubes to prevent kinks and restrictions. Secure piping away from moving objects such as engine belts and hatches. Prevent chafe on tubing as required. Test and inspect all piping and hose clamps after several hours of operation.**

# System Piping Specification

CLARK PUMP/MEMBRANE MODULE

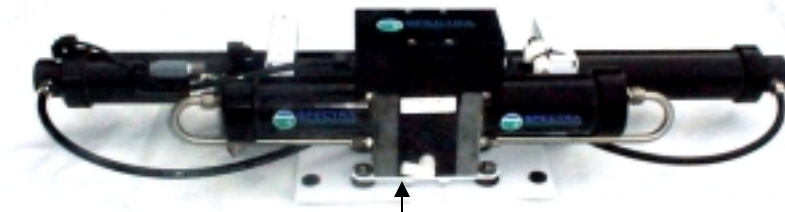

From the Clark Pump brine discharge connector use the supplied  $\frac{5}{8}$  (15.9 mm) clear braided vinyl hose to the brine overboard fitting.



The system from the pump module to the Clark Pump assembly is under pressure. Use the supplied braided clear vinyl hose rated to 150 PSI (11 bar).

PREFILTER MODULE



PUMP MODULE



FLUSH MODULE



From the inlet thru-hull to the flush module and from the flush module to the pump module inlet use the supplied clear  $\frac{3}{4}$  (19mm) spiral suction rated hose.

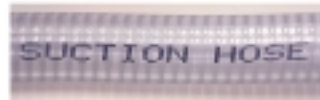

SEA STRAINER

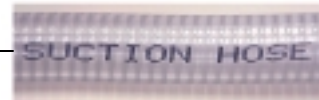
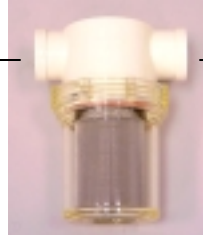

## Fresh Water Flush

Run a feed line from the domestic cold pressure water system to the  $\frac{1}{2}$  hose barb on the fresh water flush assembly. This needs to be active when the boat is unattended for the fresh water flush system to function properly. **The domestic fresh water pump must be able to deliver 2.5 gallons per minute at 25 PSI.** Connect the wiring harness and heat shrink butt splices.



## Product Water tubing

Product water tubing is  $\frac{1}{4}$ " (6.3 mm) Parker tubing. *See the Parker tube fitting assembly diagram next page.* Product water is pre-plumbed from the membrane into the electric diversion valve. The diversion valve will reject product water into the overboard brine stream until good quality is measured by the MPC-3000 control. Product water is then diverted into the fresh water tank. The salinity probe must be mounted in a vertical position with the cable coming out the bottom. If the Clark Pump/Membrane Assembly is mounted vertically or upside down the Diversion Valve/ Probe Assy should be remounted.

**You will need to route the product water from the valve into the top of the tank. Install a tee in the water fill or tap a pipe thread into an inspection port in the top of the tank. Do not feed the water into a manifold or bottom of the tank. Make sure there is no restriction in this plumbing.**

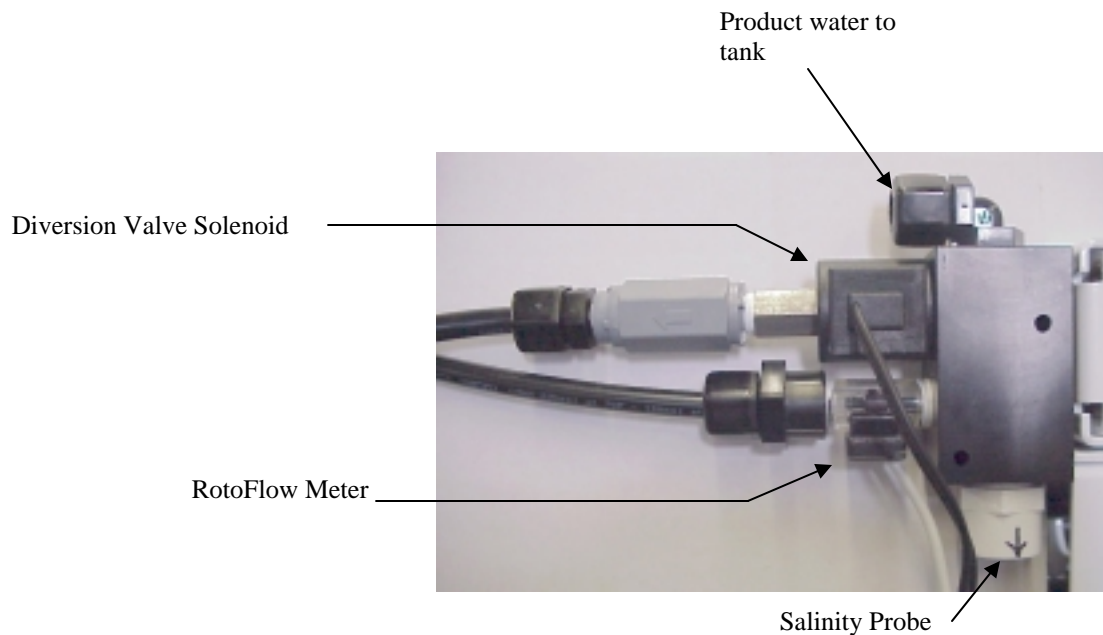

## Brine Discharge

Route the Brine discharge from the quick disconnect fitting to a location above the waterline using the supplied  $\frac{5}{8}$  (15.9 mm) hose.

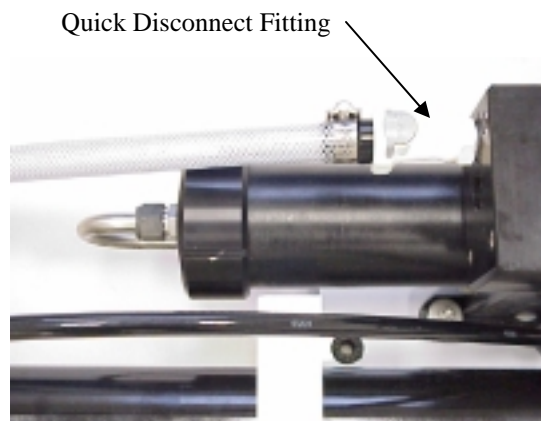

## Parker Tube Fitting Assembly Procedure

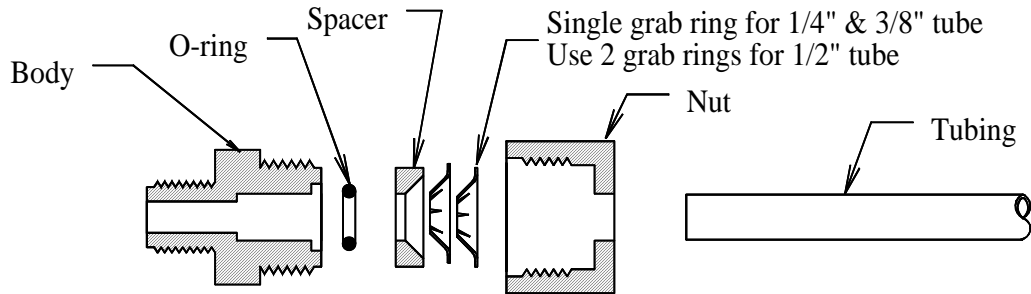

Step 1: Disassemble fitting components

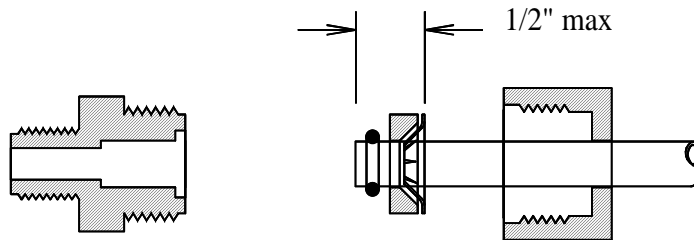

Step 2: Install the Nut first then use the bevelled side of the Spacer to push the Grab Ring onto the tube no more than 1/2". Slip the O-ring over the tube to hold the Spacer in place. If the Grab Ring is pushed too far, trim back the tube so about 1/4" of tube extends past the O-ring.

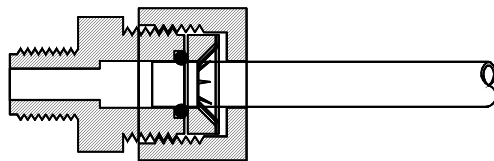

Step 3: Gently fit the tube into the body and loosely thread on the nut. Be careful not to cross-thread the nut

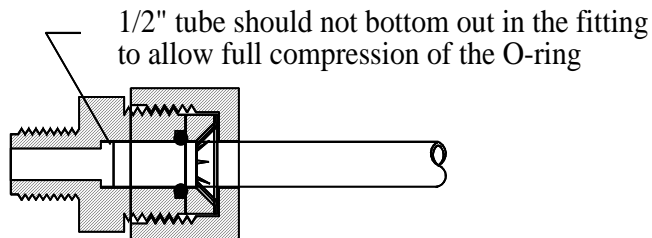

Step 4: Hand tighten the nut. **DO NOT OVER TIGHTEN!** **DO NOT USE A WRENCH!** The tube should not come out if pulled by hand. If it does, tighten the grab ring tabs.

### 1/4", 3/8", 1/2" Parker Tube Fitting Assembly

## Membrane Pressure Vessel Relocation

Use **ONLY** Dayco Imperial Nylo-Seal 88-NSR- $\frac{1}{2}$  tubing for high pressure connections. Pay attention to the direction and flow path of the tubing before disassembly. Make sure that you reinstall the tubing in the same manner. Rotate the 90 degree high pressure tube fittings on the Clark Pump for ideal tube runs. The high pressure fittings are typically pre-installed at the factory. These fittings seal with an O-ring and require no Teflon tape or pipe dope. Loosen the backing nut rotate the fitting and reseal the backing nut.

***Follow the high pressure tube connection instructions on the next page.*** Connect the tubes to one of the components, secure the tube runs, and then trim and connect to the other component. A 90 degree bend in a tube is better than a 90 degree fitting. A tube, when mounted, should have at least ***one gentle bend*** to allow for expansion. **Do not connect a tube straight between hard mounted fittings.**

When connecting the tubes to their components, be sure to hold the fitting body with a wrench during the final tightening. Of special note are the stainless steel tube fittings on the membrane housing which seal with an O-ring and should be seated all the way in. Hold the fitting with a wrench while installing the tube.

The fittings on the Clark pump have an O-ring seal and can be re-oriented by backing out the O-ring Stop nut. Rotate the fitting to align with the tube and tighten the nut **just past hand tight. DO NOT over tighten!**



# Spectra High Pressure Tube Fitting Assembly

Use **ONLY** Dayco Imperial Nylo-Seal 88-NSR-1/2 tubing for high pressure connections.

Carefully fit and measure the tubing before cutting with a sharp razor knife or hose cutter and remove any burrs. Minimum tubing bend radius is 6". Route tubing away from excessive heat sources and secure from vibration and chafe. Have at least one shallow bend in a tube assembly after it is installed.

**Refer to figure 1.** If a fitting has been disassembled, reassemble as illustrated. The notch on the ferrule must engage the inside of the nut properly for the nut to seat down fully. Once the tube is inserted the ferrule and nut will naturally align.

**Refer to figure 2.** Insert tube fully into the fitting; it should go in 0.9". Tighten the nut finger-tight while moving the tube around to prevent binding. One thread should be showing under the nut. Secure the tube so it won't back out when tightening.

**Refer to figure 3.** Use  $\frac{13}{16}$ " wrench to hold a straight body fitting or a  $\frac{3}{4}$ " wrench for a 90° body, and a  $\frac{7}{8}$ " wrench for the nut. Hold the body, recheck the tube insertion, then tighten the nut  $1\frac{1}{4}$  turns. Use the index mark on the nut as a guide. The threads should be completely covered by the nut.

Make sure these fittings are tight on initial assembly or they will fail!

**The correct torque specification is 85 foot pounds**

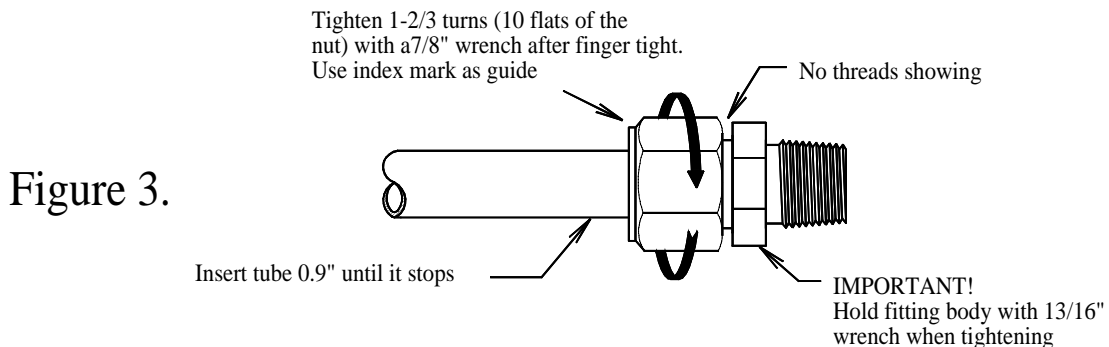
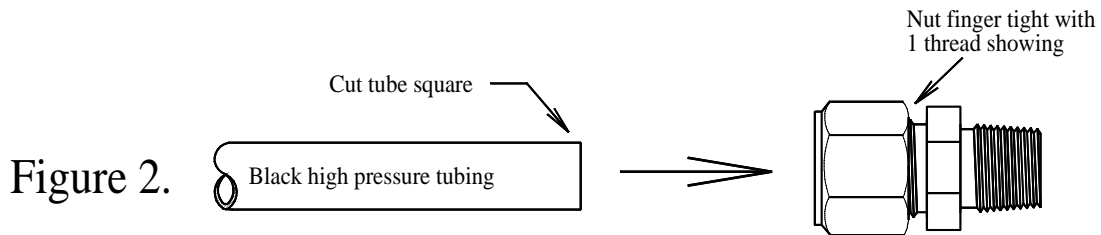
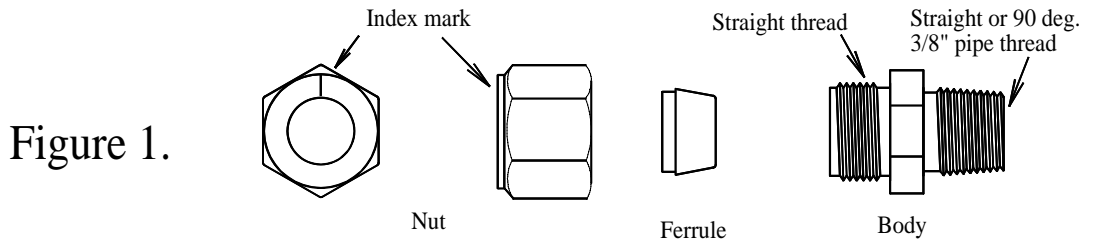

# Wiring

## Identify the cables that are connected to the MPC-3000 Control System.

Catalina Magdrive systems have a power inlet harness with a terminal block, fresh water flush cable, pressure sensor cable harness, and Clark Pump module harness consisting of the RotoFlow cable, salinity cable and the diversion valve solenoid leads. A 50' (15 M) cable with connectors is supplied for the MPC-3000 control display.

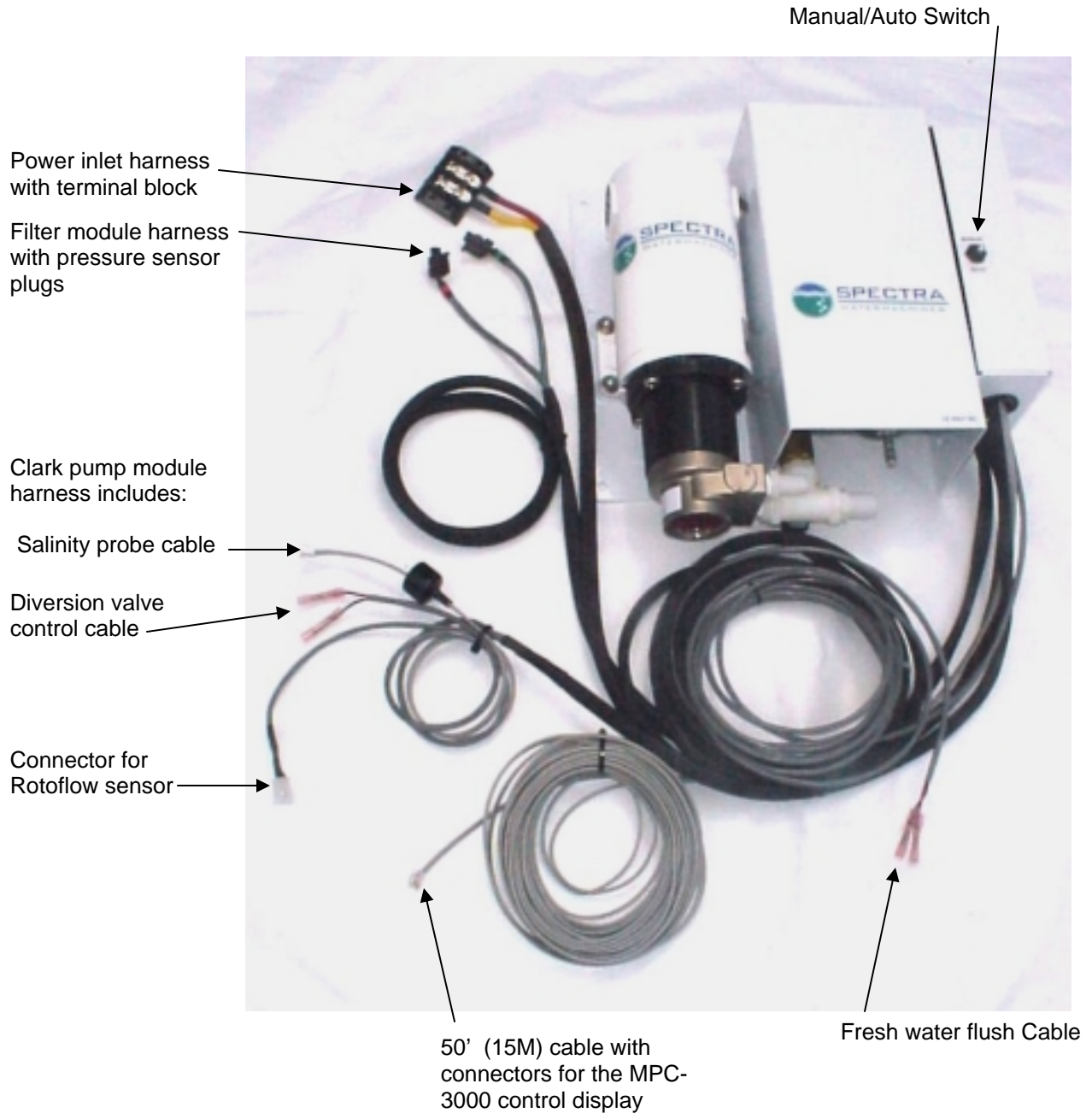

## Wiring (continued)

Mount the main power terminals on a bulkhead adjacent to the feed pump module. Make sure that this is a dry location well above bilge level and not subject to water spray.

Route the control cable through the boat to the MPC display location. Be careful not to damage the connector. Plug this into the back of the control.

Route the Clark Pump harness to the Clark Pump/membrane module location and plug in the RotoFlow meter. See photo page 15. Plug in the salinity sensor cable and install the plastic boot over the connection. Locate the diversion valve wires and splice the remaining two conductor cables with the supplied butt splices. The diversion valve wires have **no polarity**. Heat-shrink connectors or heat shrink tubing is supplied so you can seal the connections after splicing.

Route the single two conductor cable to the fresh water flush module and splice the wires to the solenoid wires. There is no polarity to the wires. Heat the splice for sealing.

Check the wire size chart to select the proper size power feed to the main power harness. DC power feeds should be uninterruptible to insure proper operation of the auto store feature. Avoid house breaker panels that could be easily tripped.

### **Component Sizing:**

- 12V- Use a 25Amp breaker and size the wiring for 20 Amperes.
- 24V– Use a 15 Amp breaker and size the wiring for 10 Amperes.
- Provide circuit protection at the source! Inadequate wiring will cause a loss of system performance. DC power should be uninterruptible.

**Note: If the specified circuit breaker sizes are unavailable, use the next higher rating but do not exceed the specification by more than 10%. All wiring to be done to applicable ABYC, Marine UL or CE standards.**

## WIRE SIZE CHART

### Catalina Mag Drive 12V DC System

Wire Length FT.	Meters	AWG.	SQ MM
10	3	10	6
15	4.5	8	10
20	6.1	6	16
25	7.6	4	25
30	9.4	4	25
35	10.6	4	25
40	12	2	35
45	14	2	35
50	15	2	35

Mag Drive 24V	Meters	AWG.	SQ MM
10	3	12	4
15	4.5	10	6
20	6.1	8	10
25	7.6	8	10
30	9.4	8	10
35	10.6	6	16
40	12	6	16
45	14	6	16
50	15	4	25

**Wire length for a pair of wires is measured from source circuit breaker or fuse to control terminal block.**

## MPC Remote Control Display Panels

There are currently two types of display options available: liquid crystal diode (LCD) display, which is dark lettering on a backlit background, or vacuum florescent display (VFD), which are bright characters on a dark background. The VFD demands more power from the MPC controller.

The displays must be mounted in a protected location, out of direct sunlight, and away from spray or dripping water. Commands to the system can be entered at any panel.

The display panels connect with the supplied 50 foot modular-type cable to the MPC board sockets marked "DISPLAYS." **Do not substitute a different type of cable!** Contact the factory if you need longer or additional cables.

Each remote control display panel can accommodate an external alarm buzzer to provide audible alerts in the event of a fault or at the end of certain timed cycles. Use only the buzzer units supplied by Spectra Watermakers, as current on the LCD buzzer terminal is limited to 20 mA, any excessive load may damage the controller or remote display panel. Connect the buzzer RED wire to the terminal marked +POSITIVE, connect the buzzer BLACK wire to the terminal marked -NEGATIVE on the back of the remote display panel.

A buzzer may also be installed at the control box, current limit is 150mA.

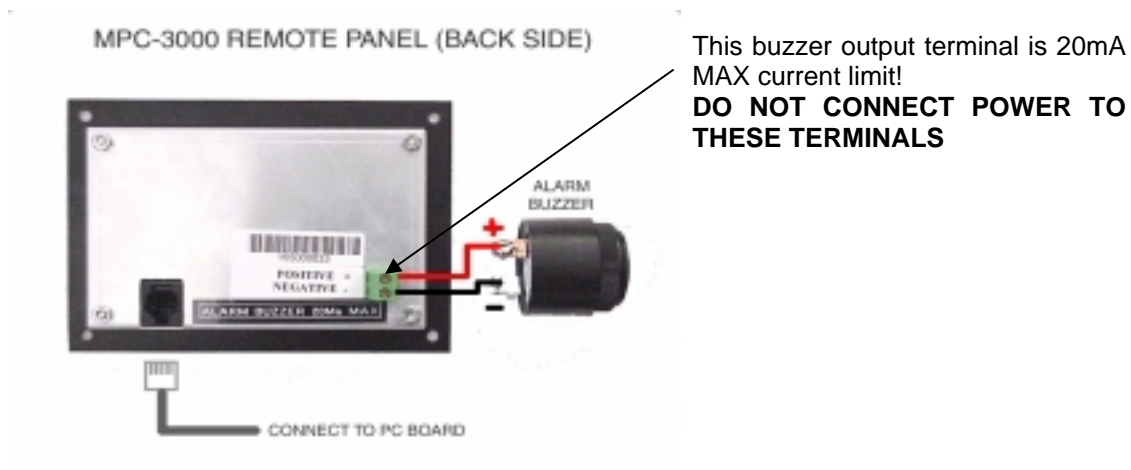

## Pressure Sensors

The pressure sensors are mounted on the filter housings to monitor system pressure and differential pressure across the filters.

If the wire leads for the sensors must be extended, you must use a minimum 18 AWG 3 conductor twisted and shielded marine grade wire. Make both sensor wires close to the same length. Make a waterproof, soldered splice connection to the new wire, and seal the splice in waterproof heat shrink tubing.

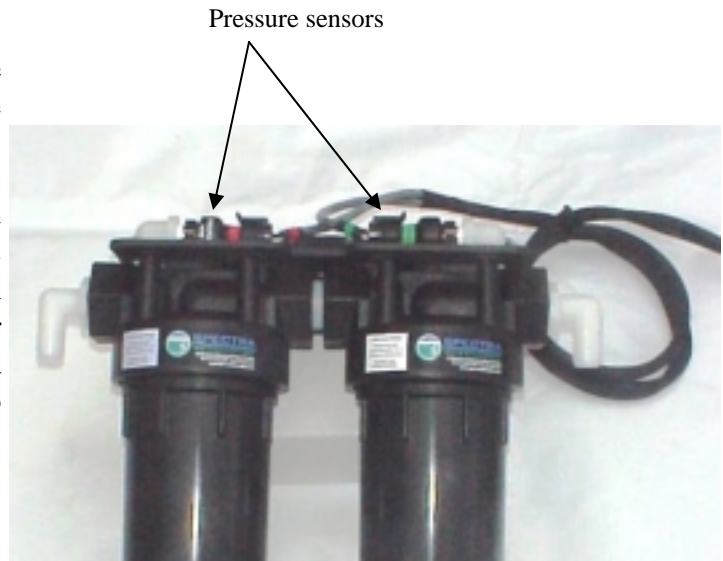

## Rotoflow Sensor

The Rotoflow sensor measures the fresh product flow and sends a pulsed signal to the MPC-3000 control.

If no flow is sensed then the MPC will fault with the code “**System Stalled**”.

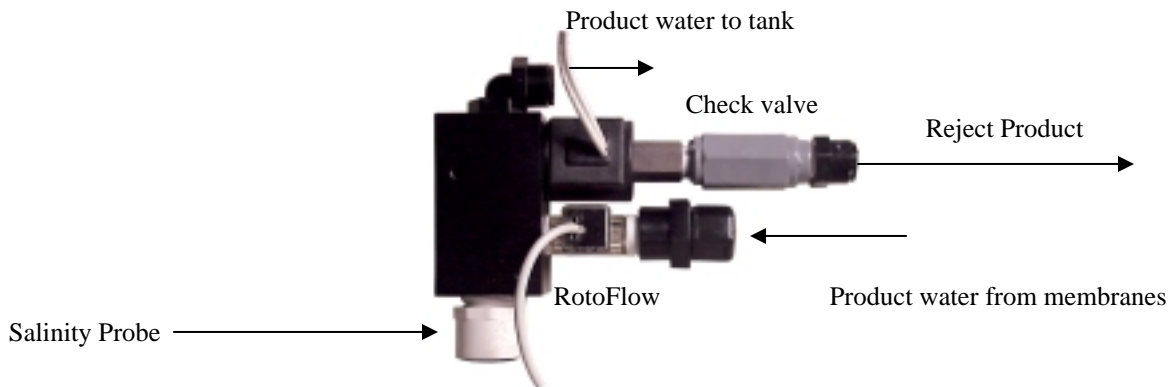

## Diversion Valve, Salinity Probe, RotoFlow Assembly

This assembly is located at the Clark Pump/membrane module on Catalina models. The salinity probe should be removed and cleaned once a year if incorrect readings occur. The probe wire is connected by a plug under the rubber boot at the sensor.

Both the diversion valve wires (two conductor) and the RotoFlow sensor (three conductor) are to be spliced with the supplied butt connectors to their respective harness. Heat the connectors to shrink.

**Note: There is no polarity or color code on the diversion valve wires. The RotoFlow wires connect red to red, black to black, and brown to white.**

## Connection of Optional Accessories

*Use of any external devices not approved by the factory may cause permanent damage to the controller and is not covered by the Spectra warranty. Accessory outputs are limited to 2 amps maximum load! Do not connect motors, pumps, etc to accessory outputs.*

**Optional Z-brane System:** Detailed instructions are included with the Z-Brane kit. Connect to an uninterruptible 12 or 24 volt DC power source.

**Ultraviolet Sterilizer:** Detailed instructions are included with the sterilizer kit. The UV sterilizer lamp module and ballast unit should mount vertically, with the product water inlet at the bottom, outlet at the top. The ballast wires plug into the end of the bulb in the lamp module. The ballast RED wire connects to “STER” terminal on the MPC board, and the ballast BLACK wire connects to the “GND” terminal. If the wires must be extended, use minimum 16AWG wire.

**External Buzzer(s):** In addition to the external buzzer(s) installed at each remote control display panel, a buzzer unit may be installed at the control box. The buzzer RED wire connects to the “BUZZ” terminal on the MPC board, and the buzzer BLACK wire connects to “GND.”

## Tank Switch Installation and Operation:

There are two sets of terminals on the MPC-3000 PCB that can be used in four different configurations to automatically start and stop the watermaker or to automatically stop the watermaker when the tank(s) are full without the auto start feature. These terminals are on the green ten pin connector and are labeled “Float Switch 1” and “Float Switch 2.” Float Switch 1 is the tank full switch and Float Switch 2 is the tank empty switch.

If the unit is wired for both auto start and auto stop, it can be put into “auto fill” mode by pushing and holding the “Auto Run” switch on the MPC-3000 display. In this mode the watermaker will start whenever the water level drops below the tank empty switch, so that it is open (not conducting electricity). When the tank fills up and both the tank full switch and the tank empty switch have remained closed for two minutes, the watermaker will shut down and flush itself. The water maker will start back up when the water level drops below the tank empty switch and it remains open for 2 minutes. This configuration allows for completely automatic operation. If the watermaker does not need to start up within five days it will automatically do a fresh water flush. Auto fill mode can be ended by pushing the stop button or the “Auto Flush” button. If the watermaker is in auto run mode it can be put into auto fill mode without stopping it by holding down the “Auto Run” button.

If the owner prefers to install the automatic shutoff feature without the automatic start up option, only the tank full switch is used. A jumper must be placed between the tank empty terminals (Float switch 2) in place of the tank empty switch, because the watermaker will only shut down if both sets of terminals are closed. To use this mode the watermaker must be started up with the “Stop/Start” button or the “Auto Run” button. After the unit starts up, then press and hold the “Auto Run” button until the display reads “**Auto Fill Mode**”. The watermaker will fill the tank and automatically enter auto flush mode.

It is possible to use the auto fill feature with 2 tanks. A double throw electrical switch must be installed in a convenient location. If only the single tank full switch is installed in each tank connect the wire from the Float Switch 1 terminal “1” to the common on the switch and run separate wires from the switch to each tank switch. The second wires can both be run to the Float Switch 1 terminal 2. If you are using two switches in each tank you will need a double pole double throw switch.



## New System Start-Up and Testing

Avoid running the system if the vessel is in contaminated water, such as in a harbor or canal. The system should be fully run tested before leaving port. It is preferable to sacrifice a filter by running the system in turbid water rather than waiting to get offshore to discover a problem or deficiency in the installation. If the location or weather prevents proper testing refer to the section “Dry Testing.”

**Warning! Damage may occur if the purge sequence is bypassed and the membrane is pressurized with storage chemical in it.**

### 1. First Check That:

- Thru-hull valve is open
- Manual / auto switch in “Auto” position
- Domestic fresh water pressure system **must be on**

### 2. Open pressure relief valve $\frac{1}{2}$ turn



### 3. Power up the system

- Alarm will sound
- Push the “Alarm/Display” button to silence alarm



4. Press Auto Run Button →



The system will go into a start mode and the feed pump will start shortly after. The system should prime within 60-90 seconds. Check the strainer and the brine discharge for water flow. There should be no bubbles anywhere in the intake hoses and the feed pump should sound smooth after priming. If the feed pump continues to sound rough, find the reason before continuing! Inspect the system for leaks.



**Note:** If you must stop the purge sequence for any reason, the control will default back to the beginning of the purging mode to protect your system. If you wish, you can bypass the purge sequence and initiate a normal start. Pressing both “Auto Run” and “Stop” simultaneously anytime during the purge sequence will bypass the purge sequence and enable a normal start. In any case **do not pressurize the system for the first twenty minutes** or more.

5. After the purge sequence. The control will alarm with the message “**Close Pressure Relief Valve**” - Close the valve and proceed by pressing “Auto Run.”
6. The system is now running under pressure and making water. The display will read “**purging product water.**” This mode dumps the product water overboard for ten minutes in case there is any residual chemicals in the membrane. Carefully inspect for leaks over the entire system! Shut down the system and repair any leaks you find.
7. The system is now in the operational mode. You may start and run your system as you desire. You will not have to go through the purging mode unless you “de-power” the system. If you do, you can bypass the purging mode by pushing “**Stop**” and “**Auto run**” buttons at the same time. It is best to use the auto-run button which defaults to the automatic fresh water rinse. If you shut down the system from the stop button then use the auto store button to effect a fresh water flush cycle.
8. Check that the system is operating within its normal parameters. Compare with the chart on the next page

## Product Flow

The Catalina Mag Drive will produce 12.5-14 gallons per hour (48-54 lph)

**NOTE:** To toggle between GPH and liters, push and hold “Alarm/Disp” for 5 seconds.



## Salinity

Salinity reads in parts per million. The system rejects water higher than 750 PPM. Anything below 500 is excellent.



## Feedwater Pressure

Pressure range 90-115 PSI (7-8 BAR)

Pressure will be higher in cold or high salinity waters and lower in warm or low salinity water. Extreme salinity or temperature conditions may result in operating pressures outside of the nominal range



## Filter Condition

Alarm occurs when filters are partially clogged. When the filters are completely clogged, the system shuts down and alarm sounds again

Clean filters on first alarm as soon as convenient. On the second alarm, the filters will need to be replaced.

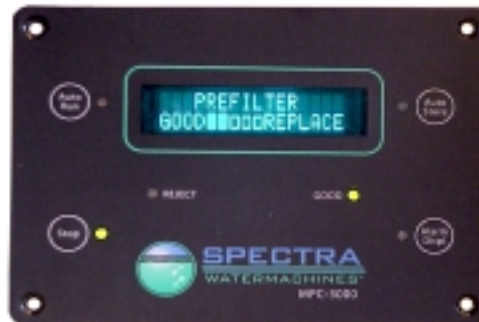

## Dry Testing With Artificial Ocean

If it is not possible to test run the system with the boat in the water, testing may be accomplished with an artificial ocean. Purchase enough aquarium salt to make 5 gallons (20 liters) of salt water.

Make sure that the domestic water system is powered up and that there is water in the tank. Confirm that the charcoal filter is installed in the fresh water flush module, and that the domestic water line had been installed and all valves are open.

1. Open pressure relief valve.
2. Power up the control system.
3. Press both “Auto Run” and “Stop” to bypass the purge sequence. If the motor starts, stop immediately and press the “Auto Run” and “Stop” button again until the message “**Purge Mode Bypassed**” is displayed.
4. Press the “Auto Store” button and allow the fresh water flush system to cycle through its timed operation. Cycle the auto store system five or more times to purge all of the storage chemicals out of the system (20 minutes total purging).
5. Hook up your service hoses per the service diagram and photos. Route them into a 5 gallon (20 liter) bucket. Disconnect the product tube from the diversion valve and using another short piece of tube, route the product water feed into the test bucket.
6. Turn the valve on the fresh water flush module from “Run” to “Service.”
7. Press auto flush one or two more times to get enough water into the bucket to properly mix your salt water. Mix the salt until it goes into solution. If you are using a hydrometer mix the water to be 30,000 PPM. Close the pressure relief valve and start the system using the “Auto Run” button.
8. Run and test the system for as long as possible. During the run test, carefully inspect for leaks. Check all of the system parameters to make sure the system is operating correctly. Do not allow the water in the bucket to get above 120°F (50°C).
9. Store the system per the “Storage” instructions.

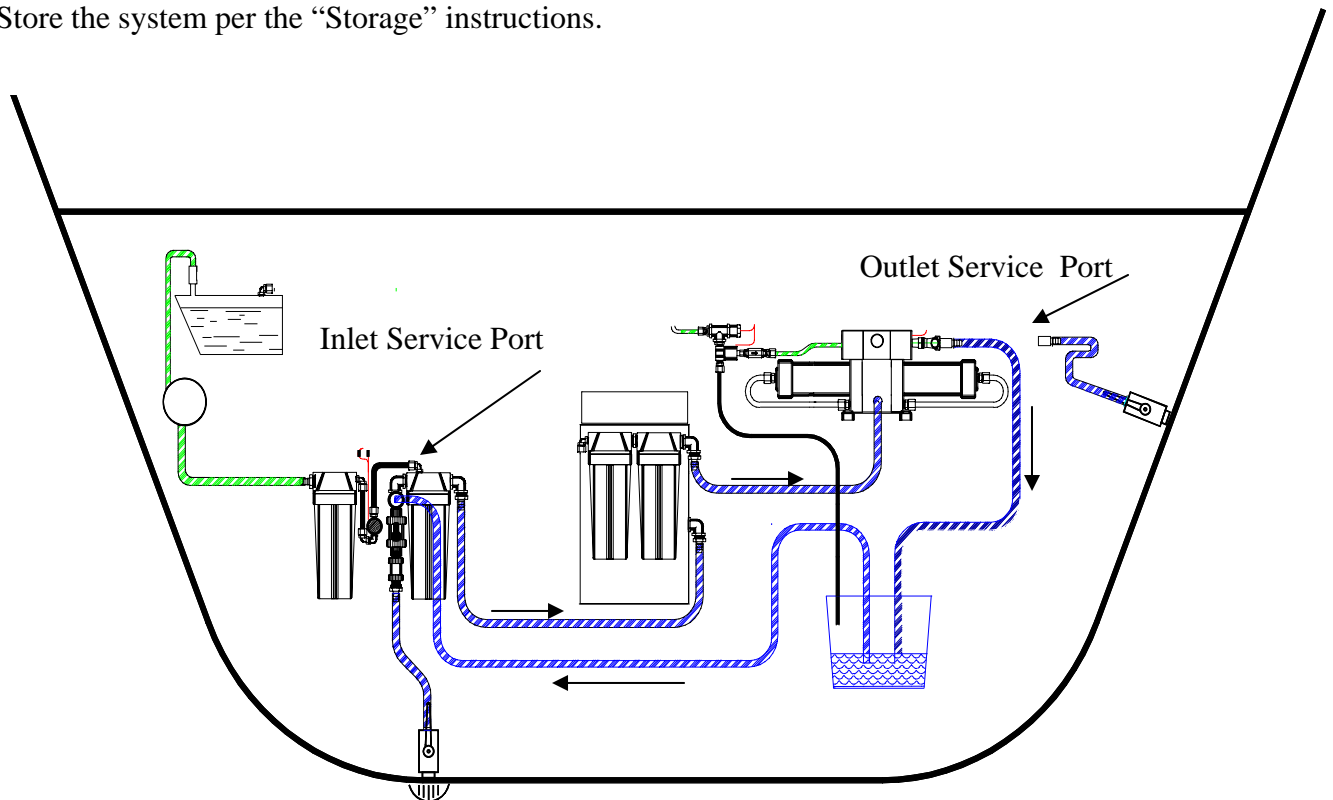

## Normal Start Up Using the Auto Run Button

**If the system contains preservative or cleaning chemicals, follow the directions for “New System Startup” or membrane damage will occur!**

- Press the “Auto Run” button once and the system will prime and run for one hour. The display reads “**Auto Run Mode**” then “**Starting**” with a 30 second priming countdown timer. After the prime, the display reads “**Auto Run Mode**” with a countdown timer. An hour of run time is added (up to 12 hours) with each successive momentary press of the “Auto Run” button. An hour can be added at any time. The display shows the default readout unless there is an alarm condition. Successive presses of the “Alarm/Display” button will scroll through the displays starting with “**GPH Product**”. Upon auto shut down by the timer or by the optional tank full float switches, the system will automatically fresh water flush and re-flush every 5 days.
- Pressing the “Stop” button stops the sequence at any time with no flushes.

### Normal Operation

- For optimum performance, auto run the system as long as possible at one time. **Never let the system sit with salt water in it.** Never allow continuous air leaks in the intake.

### Normal Shut Down

- If the system was started using the “Auto Run” button, the system will shut off on its own when the selected run time is over and will auto flush every 5 days.
- Pressing the “Stop” button at any time will shut off the system with no auto flush function.
- The optional tank float switches will shut off the system from any mode. If the system was started by the “Auto Run” button, the system will flush and then re-flush every 5 days. If the system was started by the “Start/Stop” button, it will do a one-time flush. The display will read “**Tank/s Full**”. Once one of the tank float switch opens, the alarm and “**Tank/s Full**” display will cease on its own. Note that if “**Tank/s Full**” is displayed, the system cannot be restarted.

## Automatic Fresh Water Flush Cycle

**Warning!** Proper understanding of the Spectra flush system and the vessel's fresh water system configuration is mandatory for extended automatic flush cycles. The flush cycle must not be allowed to drain all the fresh water from the vessel, or damage to the vessel's systems may occur.

**Make sure there is enough water** in the fresh water supply system to supply the watermaker for more than the expected time of operation in the "re-flush every 5 days" mode. The Catalina 300 requires 3 gallons (12 liters) every 5 days.

Make sure that the **pressure water supply is on** and will stay on during the flush mode (If this is not possible contact your certified dealer.).

Make sure that the **pressure relief valve is closed**. It should be closed if the system was just used to make water. The auto flush may not operate if the valve is open. The power for the system must remain on during the auto flush mode. Turning off the power will disable the auto flush function and damage may occur.

Pressing the "Auto Store" button momentarily will start a flush and then activate the 5 day flush cycle. The feed pump will start, the flush water solenoid will open and the display will read "**Fresh Water Flush**" with a countdown timer. After 5-7 minutes the pump will stop, the display will read "**Flush Timer Interval**," and the countdown timer will reflect the number of hours until the next flush.

Pressing and holding the "Auto Store" button for 3 seconds will engage one-time flush. The system flushes as described above, but will not re-flush every 5 days. Display will read "**Fresh Water Flush**" with a countdown timer, then the default display when finished.

Pressing the Stop button will cancel the auto flush mode.

### Checking the Flush Cycle

The length of time the flush cycle lasts, and the on time and off time for which the feed pump runs, are preset to nominal values at the factory.

After the installation is complete the flush cycle must be checked to ensure that no salt or brackish water remains in the system after the flush cycle is completed. Salt remaining in the feed pump will cause rapid deterioration of the pump's internals, and the nutrients found in sea water will allow rapid microbial growth in the membrane.

If the ship's water system is unable to provide flush water at the required flow rate, or the feed pump is running too fast during the flush cycle, sea water will be drawn in to make up the difference. At initial startup the fresh water flush system should be tested by taking a sample of the brine discharge water just as the flush cycle is ending. This water should not taste salty, and should read less than 1000 ppm on a digital tds meter. The flush cycle can also be tested by closing the sea cock during the flush cycle. If the MPC-3000 display gives a CK SEA STRAINER alarm this means that salt water was being drawn in. If this is the case the water supply should be increased if possible. Otherwise, the feed pump on and off times should be adjusted and the flush duration increased if necessary.

Instructions and software for adjusting the flush duration and feed pump on and off times are available from the factory or in the MPC-3000 Controller section under Data Sheets and Owner's Manuals on our website.

## Manual Operation

- In the event of an MPC control failure, the system may be operated manually by using the manual run switch on the MPC control box and bypassing the diversion valve.
- For manual start up, switch on the feed pump by setting the feed pump switch to “RUN MAN”. Shut the unit down if the Clark Pump does not cycle, if air is continuously present in the intake line, or if the feed pump is excessively noisy. The automatic safety controls are disabled in manual mode.
- Always discard the product water for the first few minutes of operation. The initial product water from the system may not be potable. Taste the product water before sending to a tank.
- In manual operation, the salinity control and diversion valve are inoperative. Product water is available directly from the membrane product water outlet fitting. To bypass the diversion valve, move the tube that goes to the tank from the diversion valve outlet to the membrane product water outlet as shown below.

### Automatic Operation

Membrane product outlet

Tube to tank

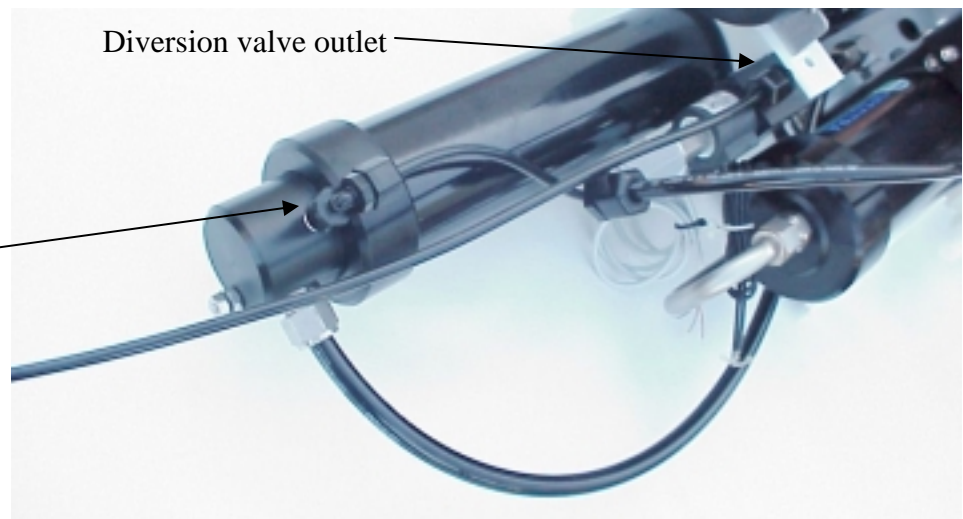

### Manual Operation

Membrane product outlet

Tube to tank

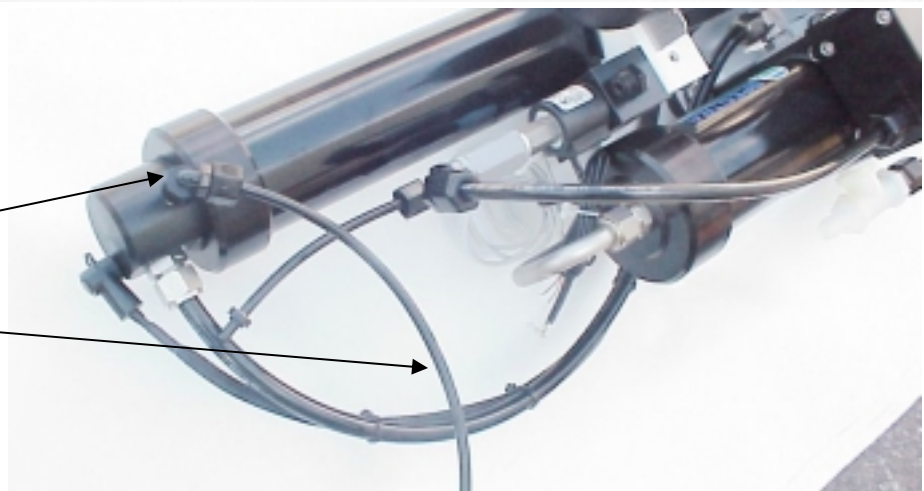

## Long Term Storage Procedures

Watermakers are best run continuously. When not in use, biological growth in the membrane is the leading cause of membrane fouling. A warm environment will cause more growth than a cold environment. The auto fresh water flush system will greatly reduce biological growth, but may not stop it completely in certain conditions. The 5 day re-flush feature allows the system to be shut down without any service procedures for extended periods of time but it doesn't replace performing a storage procedure for long periods of non-use. If an optional "Zeta Guard" water treatment system is installed in the system, the 5 day re-flush will maintain the system as long as unchlorinated pressurized fresh water is provided.

### System Storage or "Pickling"

If the system is to be left unused for more than 2 weeks, perform the following storage procedure. The procedure introduces a chemical compound into the system that prevents biological growth. This procedure requires de-chlorinated water which can be made with the Spectra's charcoal filter. **Charcoal filters last a maximum of 6 months once wetted.**

*Spectra SC-1 a special storage compound used by the US Navy. It is formulated to be compatible with the modern engineering plastics and composites in the Spectra pumps. Do not use any substitute except propylene glycol. SC-1 Storage Compound has to be mixed at a ratio of one Spectra container to three gallons (12L) of fresh water to have the proper solution. An average of 2 gallons (8L) of water is in a Newport Magdrive system. This water has to be figured in to the mixture. A NP Magdrive system uses one SC-1 container.*

**Caution! Avoid contact with skin, eyes, or lungs with the storage chemical.**



## Storage Procedure:

- Step 1: Flush the system twice. Press the “Auto Flush” button on the LCD display, once the first flush has been completed, press “Stop” to cancel the 5 day interval timer, then press “Auto Flush” again.
- Step 2: Remove the quick disconnect fitting from the brine discharge outlet of the Clark Pump, and replace with the quick disconnect hose from your service kit, and lead the hose to a 5 gallon bucket.
- Step 3: Press the “Auto Flush” button to fill the bucket with 1 gallon of fresh unchlorinated water. Press “Stop” when the bucket has reached the desired level.
- Step 4: Connect the hose, using the garden hose barb fitting from your service kit, to the service port of the fresh water flush module. Lead the hose into the bucket. Turn the service valve on the fresh water flush module 180°, so the intake is now coming from the bucket.
- Step 5: Mix the storage chemical compound into the water in the bucket.
- Step 6: Make sure the pressure relief valve on the Clark Pump is open (unpressurized).
- Step 7: Use the “Manual” switch on the MPC control box to turn on the feed pump. Circulate the storage chemical in the system for approximately 10 minutes. Turn off the pump when finished.



### Clean Up:

- Remove the quick disconnect from the Clark Pump brine discharge, and replace the original hose that leads to the thru-hull. You may at this point, if you choose to, pump the bucket dry by using the feed pump switch. Stop when the bucket is empty.
- Turn the service valve 180° back to its original position, and remove the service hose.
- Turn off the power to the system.
- LEAVE THE PRESSURE RELIEF VALVE OPEN

# PICKLING with SPECTRA SC-1 Solution

**Step 1:** Flush the system by pressing “Auto Flush” on the LCD display. Press “Start/Stop” when the flush is done, to cancel the 5 day timer. Then press “Auto Flush” to flush the system a second time. Press “Start/Stop” again when finished.

**Step 3:** Fill bucket with one gallon fresh water with “Auto Flush” button

**Step 7:** Use feed pump “Manual” switch to activate pump, run for 10 minutes

**Step 6:** Make sure pressure relief valve is open.

**Step 2:** Remove brine discharge, and replace with service hose leading to bucket

**Step 4:** Connect a service hose to service port of FWF module, and lead hose to bucket, and turn service valve 180°

**Step 5:** Mix SC-1 into bucket

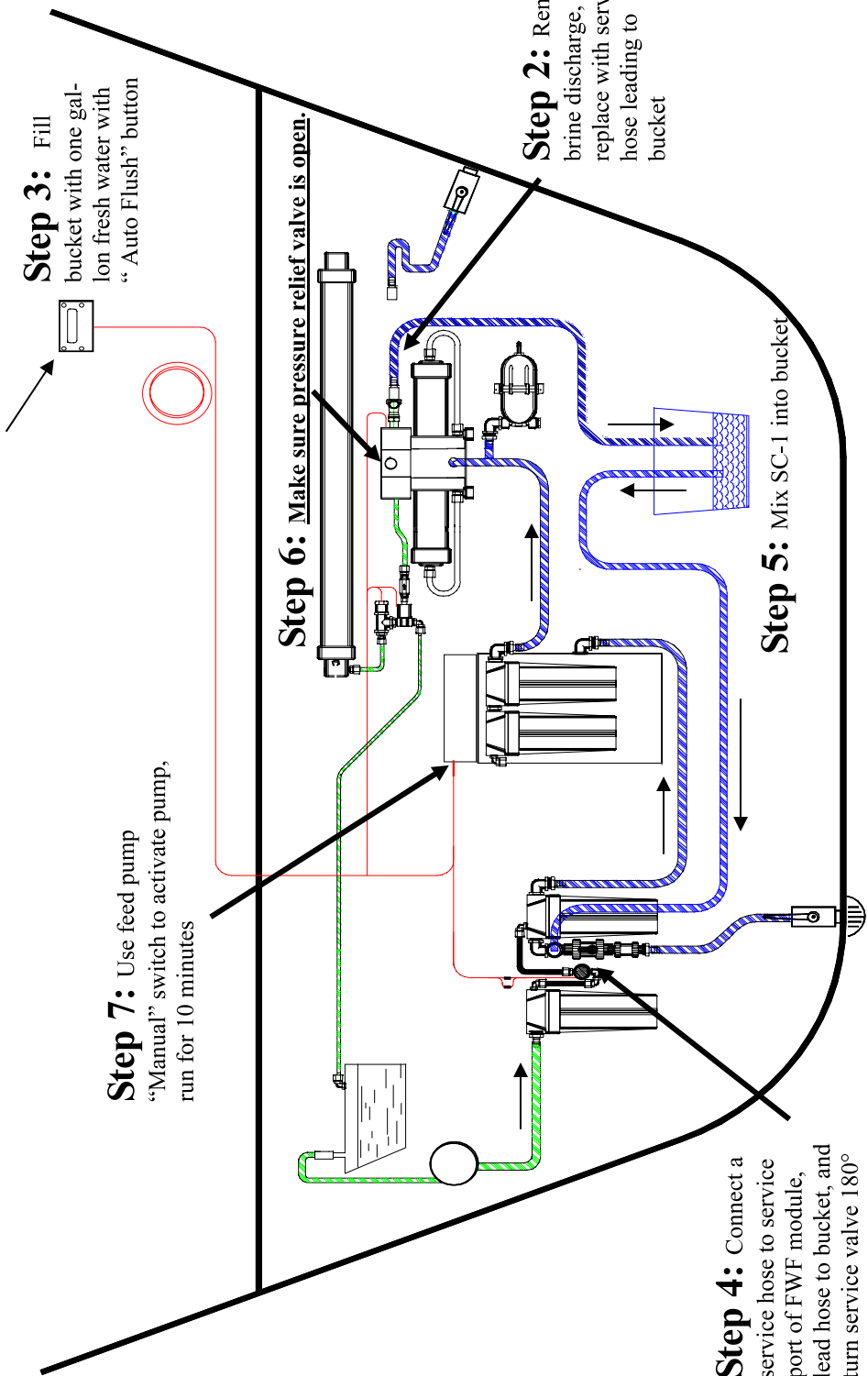

**Step 8:** You're done!

# Storage & Winterizing

**Warning! Use only potable water antifreeze (propylene glycol).  
Do not use automotive antifreeze (ethylene glycol).**

Propylene glycol is an effective biocide and antifreeze only at concentrations above 25%. Commercially available products range from 25 to 60 percent. They are usually labeled with a temperature rating. “Minus 50” antifreeze is already diluted to 25%. “Minus 100” is a 60% solution. Purchase the strongest antifreeze available. Use enough to ensure that the system contains at least a 25% solution even after dilution with the residual water inside the water-maker. You will need at least two gallons.

- Step 1: Flush the system twice using the “Auto Store” button.
- Step 2: Open pressure relief valve on the Clark pump.
- Step 3: Pour the propylene glycol into a bucket full strength.
- Step 4: Connect the hose, using the garden hose barb fitting from your service kit, to the service port of the fresh water flush module. Lead the hose into the bucket. Turn the service valve on the fresh water flush module 180°, so the intake is now being drawn from the bucket.
- Step 5: Set the switch on the pump module to “Manual” to turn on the feed pump. Run the feed pump until you see antifreeze begin to appear in the brine overboard hose. This will pump as much as possible of the water remaining inside the water maker overboard so that it doesn’t dilute the antifreeze. Set the switch to “Auto” to stop the feed pump.
- Step 6: Remove the quick disconnect fitting from the brine discharge outlet of the Clark Pump, and replace with the quick disconnect hose from your service kit, and lead the hose to the bucket.
- Step 7: Set the switch to “Manual” to circulate the antifreeze for about ten minutes. Switch to “Auto” to stop the pump.

## **Clean Up:**

- Remove the quick disconnect from the Clark Pump brine discharge, and replace the original hose that leads to the thru-hull. You may at this point, if you choose to, pump the bucket dry by using the feed pump switch. Stop when the bucket is empty.
- Turn the service valve 180° back to its original position, and remove the service hose.
- Turn off the power to the system and the MPC control.
- **LEAVE THE PRESSURE RELIEF VALVE ON THE CLARK PUMP OPEN.**

# Maintenance

## General

Periodically inspect the entire system for leakage and chafe on the tubing and hoses. Repair any leaks you find as soon as practical. Some crystal formation around the Clark Pump blocks is normal. Wipe down any salt encrusted areas with a damp cloth.

## The Seawater Strainer and 50 Micron Filter

- The sea water strainer's stainless steel element should be inspected, removed, and cleaned as needed. A clogged strainer or 50 micron filter will cause the MPC control to alarm "**Check Sea Strainer.**" Be careful to ensure that the thru-hull is closed before disassembly and the seal and element are in place before reassembly. Put the screen up to a light for inspection. When the system is put into storage, remove, rinse, and reassemble dry to impede corrosion. Check frequently during operation.
- The 50 micron filter needs to be properly maintained to protect the feed pump. Only use Spectra approved filters. These may be cleaned several times before discarding.

## The Prefilters

- Service the prefilters as soon as possible after the first prefilter alarm sounds. When the second alarm sounds the system will shut down to prevent damage. If cleaning and reusing filter elements, clean when the first segment appears on the filter condition bar graph on the LCD display.
- To service the filters shut off the thru-hull, open the housings, discard the old filters, Clean out the housing bowls, reassemble the housings with new 20 and 5 micron filter elements. The 5 micron filter goes downstream from the 20 micron. Leave dry until next startup.
- Use only Spectra approved filters or you may void your warranty. The filters may be cleaned several times with a soft brush and water in a bucket. Occasionally, lightly lube the O-rings with silicone grease.

## Oil Water Separator (Optional)

To install oil water removal capability, remove the supplied 20 micron filter element in the duplex filter set and replace with the 20 micron oil water separator cartridge. Replace this when the MPC alerts you with a "Service Prefilter" alarm.

## The Charcoal Fresh Water Flush Filter

- Replace the charcoal filter element at least every 6 months.

## The Membrane

- Membranes need to be cleaned only when feed pressures have risen 10% due to fouling or when the product quality degrades. The leading cause of fouling is from biological growth that occurs when the system is left unused without flushing or pickling. Fouling from mineral scaling can happen during operation under certain sea water conditions, and from rust. Monitor the product salinity and feed pressure bar graphs for higher than normal readings for the conditions. Other conditions that can cause high pressure are cold feed water, high salinity feed water, and clogged filters. Low product flow is more likely to be due to low voltage, poor feed, or Clark Pump performance. Look for all other causes before cleaning the membrane. Membrane life will be shortened by excessive cleaning.
- There are two types of cleaners: acid and alkaline. The acid cleaner (SC-3) will remove mineral scaling. The alkaline cleaner (SC-2) is used to remove biological by-products, oil, and dirt particles that get past the prefilters. If membrane performance is reduced and they have not been pickled recently, cleaning with both chemicals is recommended. The acid cleaner should be used first. If the membrane fails to respond to both cleanings, this is an indication of another problem with the system, or that it is time to replace the membrane. Contact Spectra Watermakers before removing a membrane.

## Membrane Cleaning

For normal cleaning, the SC-3 acid cleaning compound is used first, then the SC-2 alkaline cleaning compound. If known bio-fouling is present, the SC-2 may be used first. Using hot water (up to 120°F (45°C)) is recommended, as it greatly enhances the ability of the cleaners to do their jobs.

If the history of the system is unknown or has been left “unpickled” for an extended length of time and biological growth is present, it is recommended that the system is cleaned with SC-2, using an alternate source of unchlorinated fresh water before the system is run under pressure. A simple test can be performed to see if biological growth has occurred: before running the system, remove the prefilters and examine their condition. If the housings are full of smelly discolored water, the system was not properly stored. Install clean prefilters if they were bad. Next, check the membrane. Attach the brine discharge service hose and lead it to a bucket. Open the pressure relief valve one turn, and manually run the system for 30 seconds. Examine the brine water: if it's discolored and smells bad, perform an SC-2 cleaning with an alternate source of unchlorinated water before running the system pressurized. If the brine is fairly clean, the system can be purged, run normally, and checked for performance. Clean the membranes only if performance is reduced.

Heating the water is preferable. One way to do this is to find a camp stove and use a large stainless steel pot to heat the solution in. The cleaning solution throughout the system will heat as it circulates in and out of the pot. An alternative is to heat the one or two gallons of initial water to 120° on the main stove before mixing in the cleaner and circulating it into the system. Periodically stop and reheat the solution.

**Perform the cleaning procedures while the ship is in acceptable sea water for purging and testing.**

**NOTE: Procedures are the same for the SC-2 and SC-3 cleaners**

**Warning! The pressure relief valve on the Clark pump must be open for this procedure or membrane damage may result. Maximum pressure 50 psi.**

*A Spectra Cleaning Compound (SC-2 or SC-3) must be mixed with fresh water at a ratio of 1 container of compound to 3 gallons (12L) of unchlorinated water to have the proper solution. An average of two gallons (8L) of water is already present inside a 300 system. This water has to be figured into the mixture. A 300 system will use 1 container of compound. SC-2 and SC-3 are never mixed together. Do not use them for storage pickling solution.*

### **Cleaning Procedure:**

- Step 1: Flush the system twice. Use the “Auto Flush” button on the MPC-3000 display, once the first flush has been completed, press “Stop” to cancel the 5 day interval timer, then press “Auto Flush” again.
- Step 2: Remove the quick disconnect fitting from the brine discharge outlet of the Clark Pump, and replace with a quick disconnect from your service kit, fitted to a hose, and lead the hose to a 5 gallon bucket.
- Step 3: Press “Auto Flush” again to fill the bucket with 1 gallon (4L) of fresh unchlorinated water. Press “Stop” when the bucket has reached the desired level.
- Step 4: Connect a hose, using the garden hose barb fitting from your service kit, to the service port of the fresh water flush module. Lead the hose into the bucket. Turn the service valve on the fresh water flush module 180°, so the intake is now coming from the bucket.
- Step 5: Mix the cleaning chemical compound into the water in the bucket.
- Step 6: Make sure the pressure relief valve on the Clark Pump is OPEN (unpressurized).
- Step 7: Use the “ Manual” switch on the MPC control box to turn on the feed pump. Circulate the storage chemical in the system for approximately 25 minutes. Turn off the switch when finished. Allow to soak for several hours or overnight if the solution is cold, running the pump occasionally to agitate the solution. Set the switch to Auto when finished.
- Step 8: Turn off the control system (DC) power to reset the MPC-3000 controls. Replace the brine overboard hose. Remove the inlet service hose and turn the service valve to the “Run” position.
- Step 9: To avoid damaging the membranes, Follow the “New System Startup” instructions to purge the chemicals out of the system.



## Suggested Spares

### Short term cruising, weekends etc.

We suggest a basic cruise kit “C”. This kit consists of three 50 micron, 20 micron, and 5 micron filters each, one charcoal filter element, and two SC-1 storage chemical.

### Cruising 2 to 6 months at a time.

Two basic cruise kits, one replacement charcoal filter element, one replacement feed pump head.

### Longer than 6 months,

Additional filters, offshore cruising kit consisting of Clark Pump seals, O-rings, tools and membrane cleaning chemicals. One replacement strainer screen, O-ring for strainer screen, O-rings for filter housing

### **Spectra Watermakers parts list:**

### **Part Number**

SC-1 STORAGE CHEMICAL	KIT-CHEM-SC1
SC-2 CLEANER	KIT-CHEM-SC2
SC-3 CLEANER	KIT-CHEM-SC3
BASIC CRUISE KIT C	KIT-BCK-C
5 MIC FILTER	FT-FTC-5
20 MIC FILTER	FT-FTC-20
50 MIC FILTER	FT-FTC-50
CHARCOAL FILTER	FT-FTC-CC
5” STRAINER SCREEN	FT-STN-5S
OIL/WATER FILTER	FT-FTC-OW
FEED PUMP HEAD	PL-PMP-110MAG
FEED PUMP BRUSHES	EL-MTR-BDMBK
5” STRAINER O-RING	SO-STN-5SS
FILTER HOUSING O-RING	SO-FHS-10H
OFF SHORE KIT	KIT-OFFSH
20” MEMBRANE	FT-MB-20
40” MEMBRANE	FT-MB-40
SALINITY PROBE	EL-MPC-SP

# Spectra Watermakers w/MPC Troubleshooting Procedures

SYMPTOMS	PROBABLE CAUSE	REMEDY
Feed pump runs constantly, will not turn off	Manual override switches in “on” position	Turn off manual switch on control box
Feed pump runs with loud noise	<ul style="list-style-type: none"> <li>- Intake blocked</li> <li>- Air in system</li> </ul>	<ul style="list-style-type: none"> <li>- Check thru-hull valve</li> <li>- Check sea strainer for leaks</li> <li>- Check FWF module for leaks</li> <li>- Re-prime system (restart)</li> </ul>
No lights or display, system does not operate	<ul style="list-style-type: none"> <li>- Remote display not connected</li> <li>- No power to control box</li> </ul>	<ul style="list-style-type: none"> <li>- Check display cable connections at back of display and at control box</li> <li>- Check and reset main DC supply breaker</li> <li>- Check for voltage (12 or 24vDC) at control box power input studs</li> <li>- Try manual bypass switches; if pumps run, then control or display is defective</li> </ul>
Pumps run intermittently, cycling on/off	System operating in flush mode (DC models)	<ul style="list-style-type: none"> <li>- System will time out, or manually stop with the Start/ Stop button</li> </ul>
Display activates, but pump will not run	<ul style="list-style-type: none"> <li>- Loose or broken pump wire connection</li> <li>- Bad pump relay</li> <li>- Blown F3 or F5 fuse on MPC</li> <li>- Tanks are full</li> </ul>	<ul style="list-style-type: none"> <li>- Check wiring at terminal block inside MPC</li> <li>- Test power relay, replace</li> <li>- Replace fuse (mini automotive type ATM)</li> <li>- Check tanks– system cannot be started if tanks are full.</li> </ul>
System runs, no product water delivered to water tanks, GPH bar graph shows OK, “Good” LED activated	<ul style="list-style-type: none"> <li>- Diversion valve inoperative wiring fault.</li> <li>- Disconnected or broken product tubing</li> <li>- Diversion valve plunger</li> </ul>	<ul style="list-style-type: none"> <li>- Check wiring at diversion valve and inside control box</li> <li>- Check product tubing</li> <li>- Disassemble and clean diversion valve plunger or replace valve (contact factory)</li> </ul>
System runs, no product water delivered to water tanks, GPH bar graph shows OK, “reject” LED activated	<ul style="list-style-type: none"> <li>- High salinity of product water, causing system to reject water</li> <li>- Salinity probe out of calibration or defective, bad cable</li> <li>- Chlorine damage to membranes</li> <li>- Pressure relief valve open</li> </ul>	<ul style="list-style-type: none"> <li>- Check for low feed pressure, close pressure relief valve</li> <li>- Check for leaks at high pressure hoses</li> <li>- Test product water with handheld tester– if over 500ppm for 1 hour, contact factory</li> </ul> <p style="text-align: center;">Close Valve</p>

# Spectra Watermakers Troubleshooting Procedures

## Error Messages

SYMPTOMS	PROBABLE CAUSE	REMEDY
<p>“System Stalled”</p> <p>(“system stalled” may alarm when using the control panel to run system for servicing with the pressure relief valve open– use manual override switch instead)</p>	<ul style="list-style-type: none"> <li>- Pressure relief valve open</li> <li>- Intake thru-hull closed</li> <li>- Airlocked system</li> <li>- No signal from stroke sensor</li> </ul>	<ul style="list-style-type: none"> <li>- Close pressure relief valve</li> <li>- Check thru-hull</li> <li>- Verify stroke sensor fully inserted in pump</li> <li>- Check stroke sensor wiring at control box</li> <li>- Replace stroke sensor</li> </ul>
<p>“High Pressure”</p>	<ul style="list-style-type: none"> <li>- Blocked brine discharge</li> <li>- Fouled membrane</li> </ul>	<ul style="list-style-type: none"> <li>- Check brine discharge</li> <li>- Clean membrane</li> </ul>
<p>“Voltage Too High”</p> <p>“Voltage Too Low”</p>	<ul style="list-style-type: none"> <li>- Battery voltage too high or low</li> <li>- Loose wires or poor connections</li> </ul>	<ul style="list-style-type: none"> <li>- Charge batteries</li> <li>- Check charging voltage</li> <li>- Check power connections</li> </ul>
<p>“Re-starting”</p>	<ul style="list-style-type: none"> <li>- No signal from stroke sensor at startup. System air-locked</li> </ul>	<ul style="list-style-type: none"> <li>- See remedy above for “system stalled”</li> </ul>
<p>“Check Fuse” (followed by fuse number)</p>	<ul style="list-style-type: none"> <li>- Blown fuse at circuit board</li> </ul>	<ul style="list-style-type: none"> <li>- Replace fuse (mini automotive type ATM)</li> <li>- Look for cause</li> </ul>
<p>“Service Prefilter”</p>	<ul style="list-style-type: none"> <li>- Clogged filters</li> <li>- Loose or defective pressure sensor wires</li> </ul>	<ul style="list-style-type: none"> <li>- Install new filters</li> <li>- Check sensor wiring</li> </ul>
<p>“Ck Sea Strainer”</p>	<ul style="list-style-type: none"> <li>- Clogged strainer</li> <li>- Dirty 50 Micron prefilter</li> <li>- Seacock closed</li> </ul>	<ul style="list-style-type: none"> <li>- Clean strainer screen change 50 micron filter</li> <li>- Check through-hull and intake</li> </ul>
<p>“Salinity High”</p>	<ul style="list-style-type: none"> <li>- High product water salinity</li> <li>- Chlorine damage to membranes</li> <li>- Defective salinity probe or cable, cable disconnected</li> </ul>	<ul style="list-style-type: none"> <li>- Check for low feed pressure</li> <li>- Check for leaks at high pressure hoses</li> <li>- Remove and clean probe contacts check calibration.</li> <li>- Check cable connections</li> <li>- Clean membrane</li> </ul>

## Operation and Repair Bulletins

The following documents are sections of our complete service bulletin set. These are available on our website at [www.spectratemakers.com](http://www.spectratemakers.com)

### MB-2 MEMBRANE CARE

Membrane life is affected by a large number of factors and is somewhat unpredictable. A big commercial plant running 24/7 will get 10 to 12 years out of a set of membranes. But they do all kinds of fancy chemical injections and never shut the thing off. Most cruisers are lucky to get five or six years out of one. You hear of the eight or ten year old membrane now and then. The biggest killers of membranes are lack of use, chlorine damage, and improper storage.

Don't let membranes sit around with sea water or stale fresh water in them. Biological growth will occur in the membrane. Here at the factory we frequently get back membranes for inspection that reek of hydrogen sulfide (rotten eggs). This odor is produced by anaerobic bacteria that live in an unused membrane, feeding on whatever animal or vegetable matter is trapped in it from the plankton that gets through the system. Membranes badly fouled in this way can seldom be saved. These bacteria are always present but are inhibited by the oxygen in sea water while the unit is in frequent use, by scheduled fresh water flushes, or by pickling. Keeping the prefilters clean is also important in preventing bio-fouling. If your prefilters are allowed to become a breeding ground for bacteria (get smelly), the contamination will spread throughout the system. When we cut open a failed membrane we also find mildew, another form of bio fouling, probably due to long term storage with no biocide or stale biocide.

After many hours of water making mineral deposits will form and must be dissolved away with an acid cleaner. Alkaline cleaners are used for bio-fouling. Cleaning chemicals, especially the alkaline, are not good for the membrane. Every time you clean the membrane it shortens its life. Clean only when necessary, and avoid cleaning as a "diagnostic tool".

Chlorine will destroy a membrane in minutes. It attacks the material that the membrane is made from. Always use product water or water filtered slowly through a charcoal filter for flushing and chemical treatments.

Oil simply plugs up the matrix of the membrane and clogs it up. We have brought back oil fouled membranes with Joy soap (See MB-5 Cleaning with Detergent.)

For storage we recommend using propylene glycol potable water system antifreeze if available. It can safely be left in the system for one year and will keep things from freezing in cold conditions. It is hard to find in warm climates, and takes up a lot of room on a small boat, so our SC-1 is best for tropical cruising.

Given good care a membrane will eventually just start to slowly fade away. The feed pressure may rise and/or the ppm go up. Hardly ever will they just fail overnight.

8/13/04

## MB-5 MEMBRANE CLEANING WITH DETERGENT

If the membrane has been fouled with oil it may be possible to save it by cleaning it with dish soap such as Joy. Don't use anything that may contain bleach. You will need quite a lot of chlorine free fresh water. If using shore water run it through a charcoal filter at a rate of not more than 1.5 gallons (6 liters) per minute.

Fill a bucket with fresh water and mix in a couple squirts of the detergent. Run the system depressurized with the watermaker drawing water from the bucket and discharging overboard. When about half the water is gone from the bucket stop the unit and let the membrane soak for a few minutes. Restart and pump the remaining solution overboard. Repeat until the discharge appears clean.

After most of the oil is cleaned out you can put the brine discharge into the bucket and run the system with the soapy water circulating as you would for the other cleaning chemicals. Rinse the system with a bucket of fresh water or the fresh water flush cycle, then flush for twenty minutes using sea water. Pressurize and test.

5/12/04

## MPC-5 PURGE MODE BYPASS

Whenever the control power (12 or 24 volt DC) has been shut off the system will prompt you through the purge mode when it is turned back on. This is because the only time the MPC-3000 should be turned off is after the system has been pickled. Purge Mode prompts the operator to open the pressure relief and then runs seawater through the system for 20 minutes to clear away the chemicals. Normally, during periods of disuse the MPC-3000 will remain powered up so that it can do the five day flush cycles, and no storage solution will be present. If the control power has been interrupted but the system is not filled with storage solution, Purge Mode can be bypassed by tapping the two left hand buttons at the same time until the display reads PURGE MODE BYPASSED. The buttons must be pushed at exactly the same time. You can't hold one down and then push the other. From Purge Mode Bypassed you can run the system in any mode. 4/20/04

## OP-1 WINTERIZING OR PICKLING W/ ANTIFREEZE

**WARNING:** Use only propylene glycol based drinking water system antifreeze. Do not use ethylene glycol based automotive antifreeze, which is toxic.

Propylene glycol can be used instead of Spectra SC-1 storage chemical for storage in any climate up to one year following this procedure.

1. Replace the prefilters with clean ones.
2. Flush the system with fresh water until the brine discharge water is below 1000 ppm or until the brine discharge does not taste salty.
3. Set up the system for pickling according to the directions for your model.
4. Place enough antifreeze in a bucket to fill your system. This will be about two gallons for a 150 or 200 model, three gallons for a 380 or 400, and larger systems will take more.
5. Run the system DEPRESSURIZED with the feed pump drawing from the bucket and the brine discharging overboard until the colored antifreeze solution begins to appear at the brine discharge then switch the brine discharge into the bucket and recycle the remaining solution until the glycol and water are completely mixed, (about ten minutes). On some models you will have to shut down the unit to switch the brine discharge into the bucket.
6. The product water side of the system will not contain antifreeze and should be protected from freezing by blowing or draining it dry if necessary.
7. Turn off power to the system, leaving the pressure relief valve open ½ turn.

5/25/04

## OP-2 BAD SMELLING PRODUCT WATER

The reverse osmosis membrane is permeable by many gases including hydrogen sulfide, the gas that causes rotten eggs to smell the way they do. If there are bad odors in the feed water they will go through the membrane and the product water will be affected. Usually the source of the odor is from the decay of planktonic creatures trapped in the sea strainer and prefilters. These tiny oxygen loving creatures soon suffocate and die inside the prefilter housings when the unit is shut down. Once all the available oxygen is consumed, anaerobic bacteria begin to grow, causing the odor. If a unit being used frequently begins to make smelly water, it will be the prefilters that are the source of the problem. This occurs in a week or two in cold climates, but in less than one night in very warm waters like the Sea of Cortes or Red Sea. These bacteria can spread throughout the watermaker, and begin to grow on the membrane, causing poor water quality and high feed pressures.

Filling the system with fresh water after every use greatly slows this process, allowing the automated spectra units to operate with less frequent prefilter changes, but units operated for only an hour or so a day will probably need to have the filters changed due to odor before they are dirty enough to restrict water flow. Prefilters can be cleaned. We recommend that you have three sets in service, one in the unit, one set soaking overnight in a bucket of clean fresh or salt water and one set drying for the next use. After shutting down the unit remove the used prefilters and install the dry set. Leave the housings full of air until the next use. On non-automated systems, open the pressure relief when starting if there is a lot of air in the system until the air is cleared out through the brine overboard. The filters will get just as clean when soaked in sea water, but dry much faster if soaked in fresh. Given gentle handling, prefilters can be reused many times.

Bad smelling product water is usually caused by bad smelling feed water, but can also be caused by a fouled membrane if the membrane has been left unpickled. If the unit makes smelly but not salty water after a long idle period and the prefilters are new, the smell can be eliminated by running the unit unpressurized for an hour or so to flush the membrane.

Odors in the product water can also be eliminated by adding a charcoal filter in the product water line. Spectra offers a product water filter kit p/n KIT-FLT-CC.

More on this subject is available on our website at [www.spectrawatermakers.com](http://www.spectrawatermakers.com).

8/17/04

## OP-4 FRESH WATER FLUSH

The purpose of the fresh water flush is to replace the sea water in the watermaker with fresh water whenever the system is not operating. The Auto Flush Mode changes the fresh water every five days if the system has been idle that long. The watermaker will last longer and operate better if it is always kept filled with fresh water between uses.

Most spectra watermakers are equipped with a fresh water flush module. This module includes a 50 micron filter to filter out abrasive particles in the feed water that might damage the feed pump, a charcoal filter to remove any chlorine in the fresh water that might damage the membrane, an electrically operated valve and a check, or “one way”, valve. The electrically operated solenoid valve opens during the fresh water flush allowing the boats pressurized water system to supply water to the system. The check valve prevents the fresh water from going out backwards through the sea strainer and sea cock. The charcoal filter has a maximum flow rate of 1.5 gallons per minute (6lpm) so the feed pump is operated at a reduced speed on some models, or is cycled on and off on other models, to avoid exceeding this flow rate.

If the ship’s water system is unable to provide flush water at the required flow rate, sea water will be drawn in to make up the difference. This will cause the flush water to be brackish, and ineffective in preserving the watermaker. At initial startup the fresh water flush system should be tested by taking a sample of the brine discharge water just as the flush cycle is ending. This water should not taste salty, and should read less than 1000 ppm on a digital tds meter. The flush cycle can also be tested by closing the sea cock during the flush cycle. If the MPC-3000 display gives a CK SEA STRAINER alarm this means that the fresh water supply is insufficient.

Because the pre-filters trap the plankton in the feed water they can be subject to “going anaerobic” or starting to smell like rotten eggs, as the trapped plankton decay. For this reason it is advisable to always put in clean elements if the unit is going to be left on Auto Flush Mode. In daily or regular use the fresh water flush after each shutdown will help prevent this problem, but in excessively warm or fertile waters the pre-filters will need regular attention.

7/26/04

## PF-1 PREFILTERS- VANE PUMP SYSTEMS

Five different filters are used on these Spectra Watermakers to make sure that no damaging foreign materials enter the system. There are four filters in the system to clean the feed water of abrasive materials while the system is in operation, and a fifth filter that prevents the entrance of chlorine during fresh water flushing.

During normal operation the feed water is filtered in two stages. First it enters a fine mesh metal sea strainer then passes through a fifty micron pleated cellulose filter. These protect the vane pump from damage due to abrasion from silt and hard shelled plankton found in the feed water. After passing through the pump the feed water enters the filter housings containing 20 and 5 micron elements. These filters remove very fine particles which could damage the Clark pump and which would shorten membrane life.

Cleaning schedules will vary widely depending on how and where the system is used. If large amounts of feed water are run through the system in a relatively short period in biologically fertile near shore waters, the prefilters will plug up, the pressure drop across the filters will rise, product production and quality will drop, and the system will sense plugged filters and give a service prefilters or check strainer alarm if so equipped. Plugged filters can be cleaned several times by soaking in a bucket, towing behind the boat at moderate speeds, or hosing them off.

When operated only an hour or two a day in inland or near shore waters, the trapped plankton will begin to decay in the filters long before the elements plug up, and the bacteria involved in the decay will cause a "rotten egg" smell in the product water. This decay will set in overnight in tropical waters, or after a week or two in high latitudes. If handled gently and changed regularly before they get too smelly, filters in this service can last through dozens of cleanings.

In crystal clear blue water conditions the filters may need to be cleaned much less frequently.

The charcoal filter used in the fresh water flush system will not plug up unless you have some incredibly dirty domestic water in your boat. About six months after installation the charcoal filter element will lose its effectiveness at removing any membrane damaging chlorine which may be present in domestic water. Charcoal filter elements must be replaced every six months if there is ANY chance that chlorine could be introduced into the flush water. Charcoal filter elements cannot be cleaned.

To ensure that filter elements fit properly and remove chlorine effectively, they should be purchased at factory authorized dealers. Our element part number is FT-FTC-XX. The last two digits indicate the micron rating, e.g. FT-FTC-05 is for a 5 micron element. Charcoal elements are FT-FTC-CC.

06/03/04

## PF-2 CHARCOAL FILTERS

The function of the charcoal filter element, p/n FT-FTC-CC, is to remove any chlorine in the fresh water flush water supply. It also removes any particulate matter. The charcoal filter we use removes 99.7% of the chlorine. Beware when buying other charcoal filters. If they don't specify the percentage of chlorine removed, don't use them. The cheap ones in most cases will only remove 60 or 70%. Also, there are aftermarket filters which are very close to, but not exactly, the same dimensions that will not seal properly in the housing. The membrane can only handle small amounts of chlorine for short periods without damage. The chlorine will damage the bonding agent in the membrane in a very short time. So if you skimp on the charcoal filter you will toast a \$450.00 membrane on the first flush. The other factor is the flow rate that the filter can handle. Because the chlorine is deactivated by a chemical reaction with the charcoal, it must remain in contact with the charcoal for sufficient period of time for the reaction to be complete. The filter we use can handle 1.5 gallons (6 litres) per minute flow, and are good for 3000 gallons (12,000 litres) at 1.5 GPM, or six months, whichever comes first. Regardless of the flow the charcoal loses its effectiveness after six months.

7/26/04



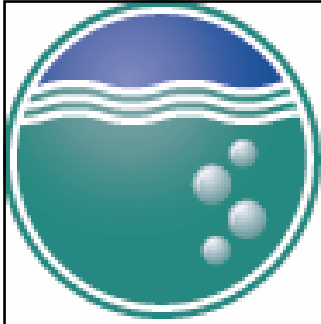

**SPECTRA**  
WATERMACHINES™

Z-BRANE  
OPERATION  
MANUAL



The **Z-brane** is a revolutionary product which incorporates the Z-Guard High Voltage Capacitive technology into the membrane pressure vessel. Always active, the Z-Brane creates an environment that is unfriendly to bio-film and bacteria. The Z technology also assists in the prevention of scale formation on the membrane surfaces. The Z-Brane allows the system to be shut down or decommissioned for extended periods of time without chemicals or preservatives. The Z-Brane will not prevent freezing so that in cold climates Propylene Glycol is still required.

The Z-Brane system is integral with the watermaker unit and only requires continuous 12V or 24V DC power to be operative. The installation of the Z-Brane only consists of wiring the power supply to a continuous source. The Z-brane power supply can tolerate voltages between 10V and 28V DC.

**Note: There is no reason to open the transformer enclosure. Do not service this unit without disconnecting the power source! There may be high voltage present.**

It is recommended that the Z-Brane be connected to a discreet continuous power source. The power must be on during the time that the system is operation and during the time the Z-Brane is used for membrane storage. If the power is obtained from the MPC then the MPC must be powered up at all times during storage. This may not be desirable.

Fuse the power at the source with a 5 amp fuse or circuit breaker.  
**Red is Positive (+) , Black is Ground (-)**



Z-Brane Power Harness

## Operation

During normal operation the Red LED should be on . Power needs to be supplied to the Z-Brane unit at all times that you wish to have the biofouling and scale protection. We recommend that your watermaker be flushed after each use not only to protect the membrane but to prevent corrosion in the feed water system. To achieve full effectiveness thoroughly fresh water flush the watermaker several times before leaving the vessel.

The Z-Brane may be de-powered if the system is stored with chemicals or winterized with Glycol.

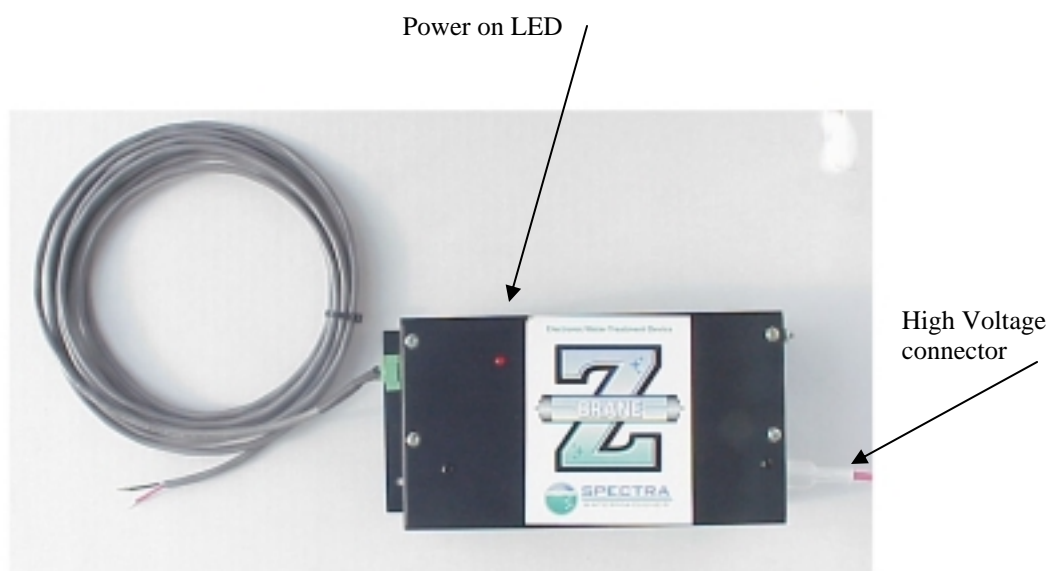

**DO NOT DISCONNECT  
OR SPLICE ANY OF THE  
HIGH VOLTAGE WIRING!**

Contact the factory if  
modifications are required.

# CATALINA MPC PART NUMBERS

**EL-SSR-150**  
PRESSURE TRANSDUCER  
(150 PSI)

**PL-MFF-1/4X1/4**  
1/4"MPT X 1/4" FPT ELBOW  
NYLON

**FT-FHB-10HD**  
HIGH PRESS. HOUSING  
BRACKET DUPLEX

**PL-MTE-3/4X1/2P**  
3/4"MPT X 1/2" TUBE  
FITTING ELBOW

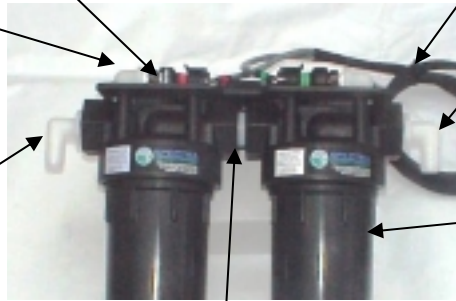

**EL-SSR-PSH**  
PRESSURE SENSOR  
CABLE

**PL-HBE-3/4X5/8**  
3/4"MALE NPTX5/8"HOSE BARB  
ELL NYL.

**FT-FTH-10H**  
HIGH PRESSURE FILTER HOUSING

**PL-NP-3/4N**  
3/4" CLOSE NIPPLE NYLON

**PL-MTE-3/8X1/4P**  
3/8" MPT X 1/4" TUBE FITT.  
ELBOW

**SUB-NP-DVM**  
DIVERSION VALVE  
MANIFOLD

**EL-MPC-SP**  
SALINITY PROBE

**EL-SSR-IFM**  
INLINE FLOW METER  
SENSOR

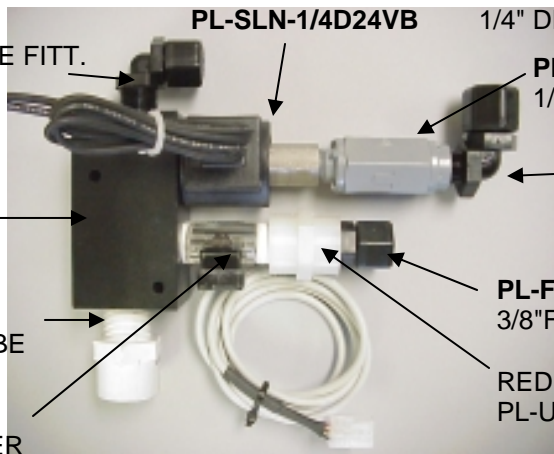

**PL-SLN-1/4D12VB** 1/4" DIVERSION VALVE 12V W/O VB  
**PL-SLN-1/4D24VB** 1/4" DIVERSION VALVE 24V W/O VB

**PL-CKV-1/4M-F**  
1/4" PLASTIC CK VALVE (M-F)

**PL-MTS-1/4X3/8P**  
1/4"MPT X 3/8" TUBE  
FIT. ST.

**PL-FTS-3/8X1/4P**  
3/8"FPT X 1/4" TUBE FITT ST.

REDUCING COUPLING  
**PL-UNN-3/8X1/4N**

**PL-ACC-TK**  
ACCUMULATOR

**PL-HBS-3/4X1/2**  
3/4X1/2NPT HOSE BARB NYLON

**PL-TEE-1/2FN**  
1/2NPT NYLON TEE

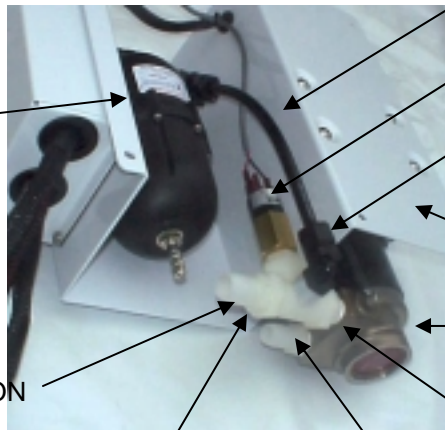

**PL-NLT-3/8LP** NYLON TUBE

**EL-SWT-VC** VACUUM SWITCH

**PL-MTE-1/4X3/8P** TUBE ELBOW

**EL-MTR-1/6D12** 12 Volt Motor  
**EL-MTR-1/6D24** 24 Volt Motor

**PL-PMP110MAG** Feed Pump Head

**PL-NP-1/2X3/8N** 1/2X3/8 NPT  
NYLON NIPPLE

**PL-HBS-3/8X5/8**  
3/8"MPT X 5/8" HOSE BARB  
STRAIGHT



MPC CONTROL PANEL (VFD)  
EL-MPC-RMCDP

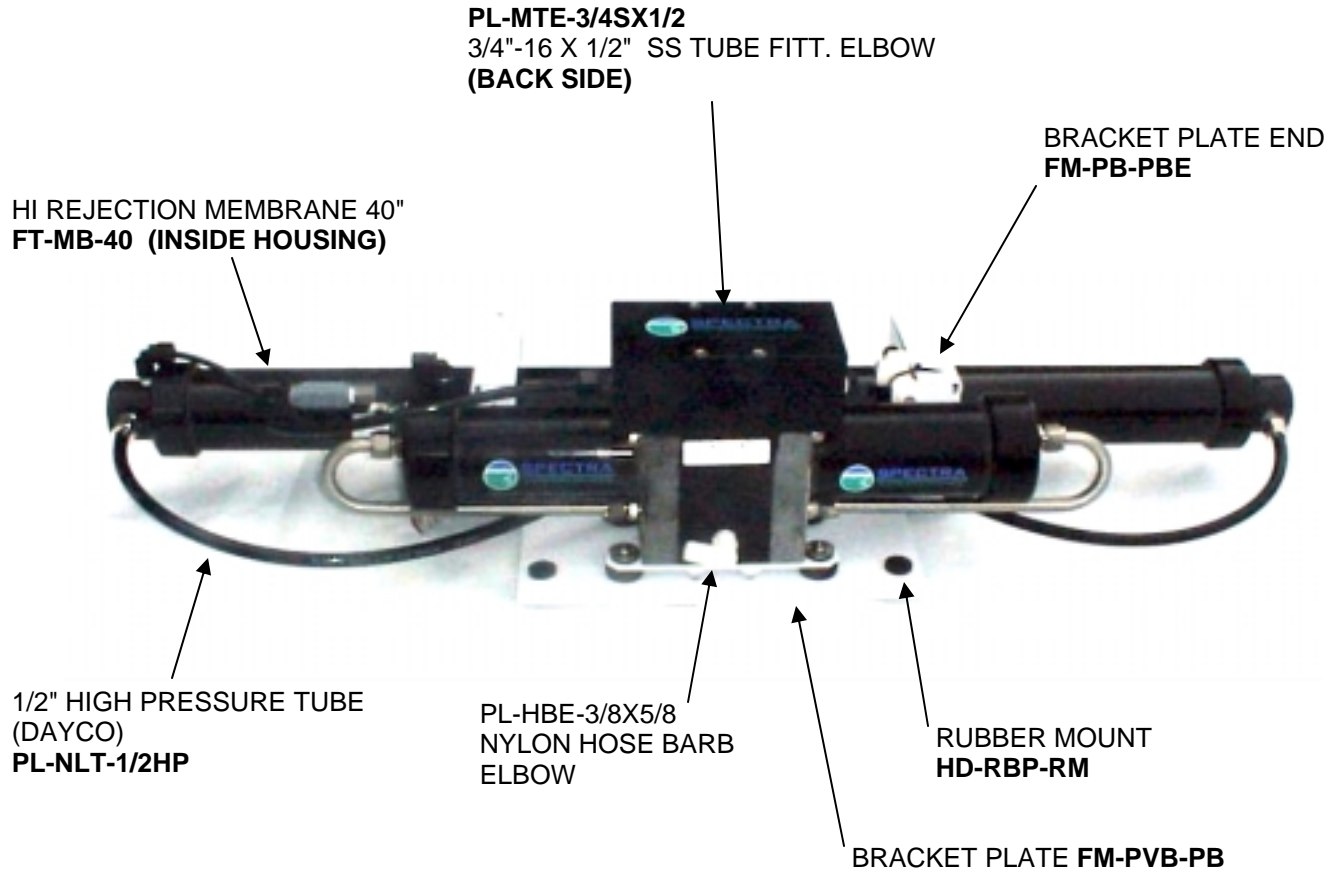

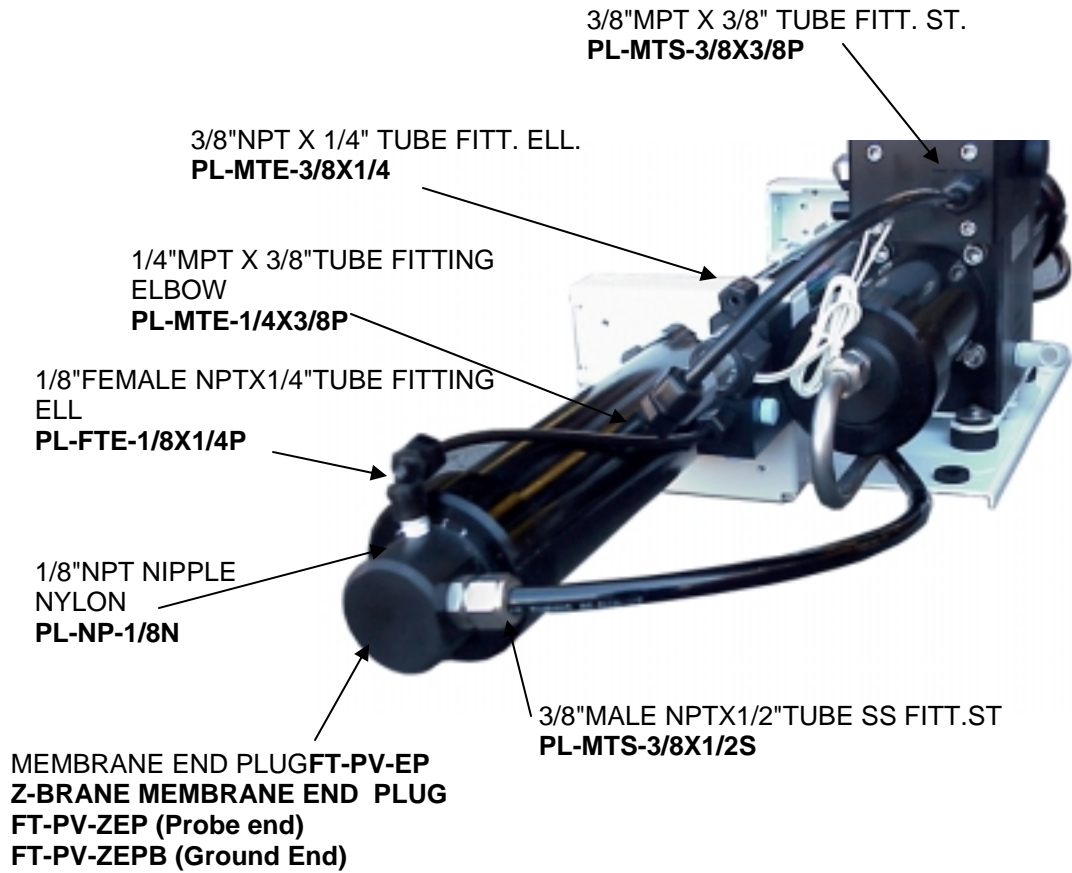

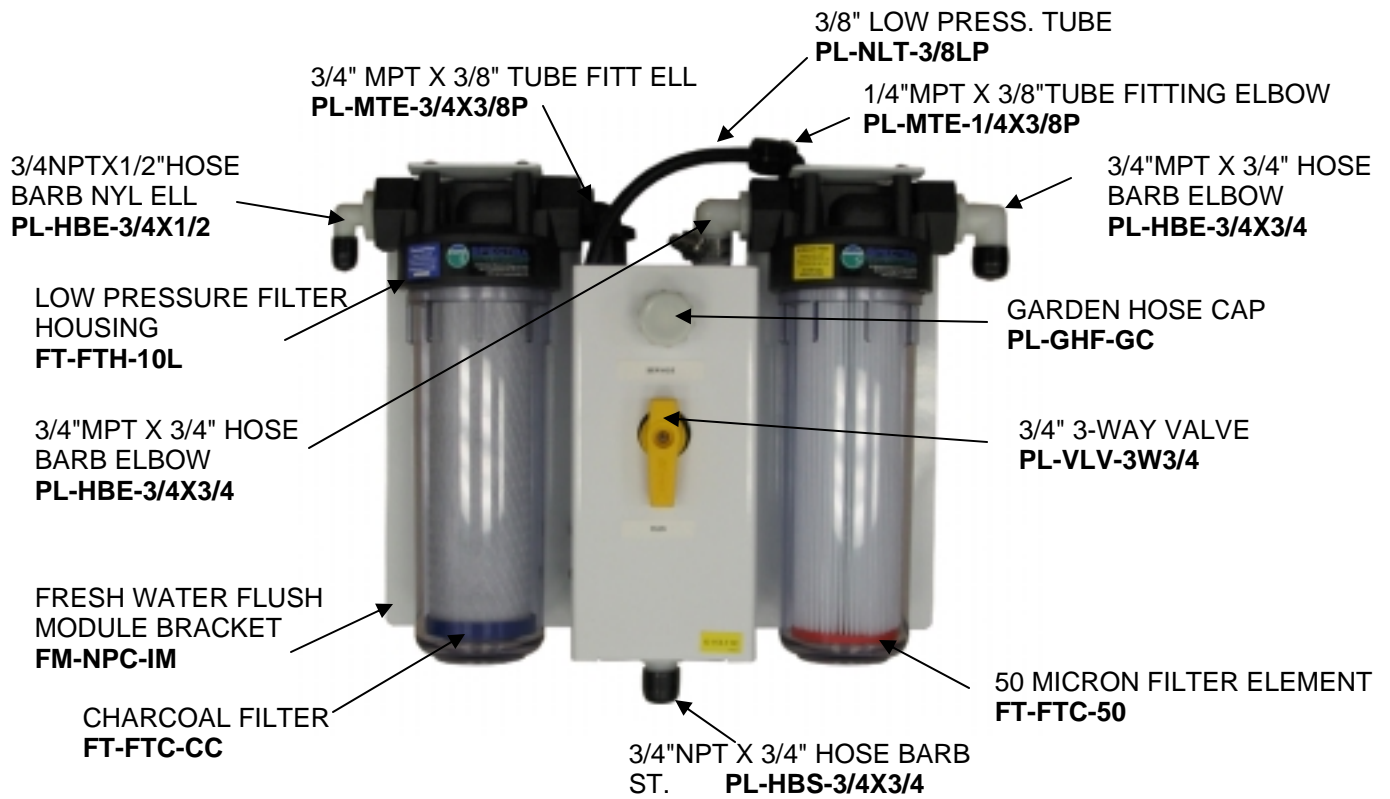

NOTE: LOCATED INSIDE ARE

1. CHECK VALVE **PL-CKV-3/4F-F**
2. SOLENOID VALVE **PL-SLN1/4D12** 12 VOLT  
**PL-SLN1/4D24** 24 VOLT

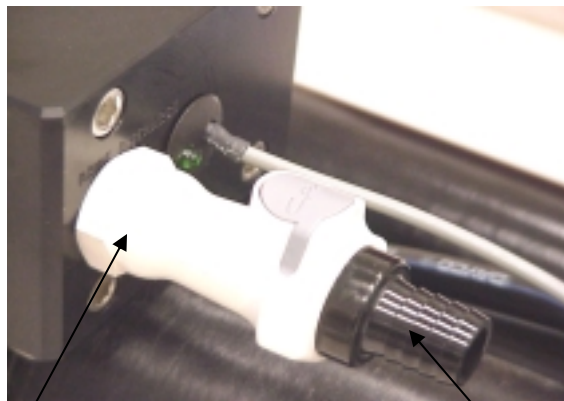

3/8" NPT QUICK DISCNT. COUP. BODY  
**PL-QDC-BD3/8**

5/8" QUICK DISCNT. FITT. HOSE BARB  
**PL-QDC-HB5/8**

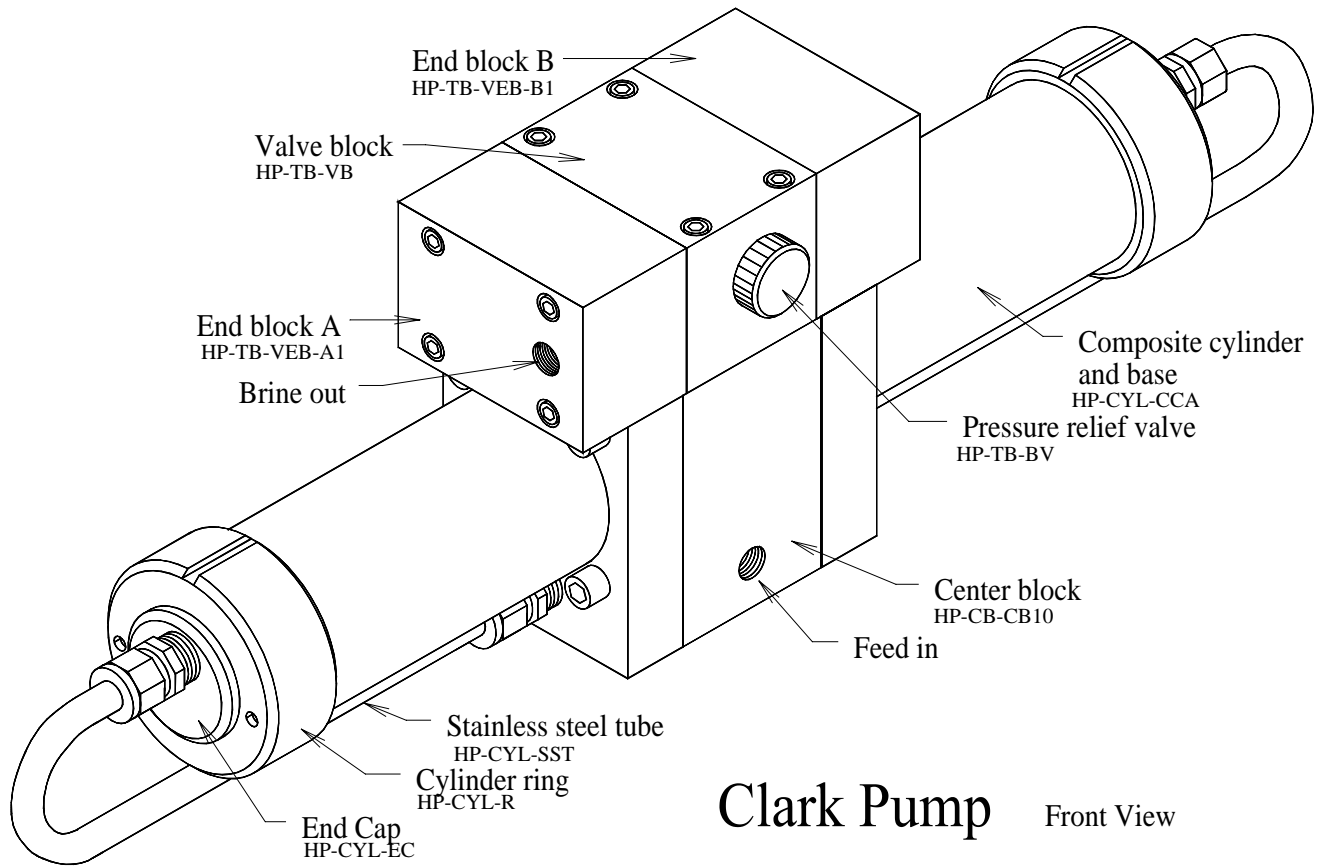

**Clark Pump** Front View

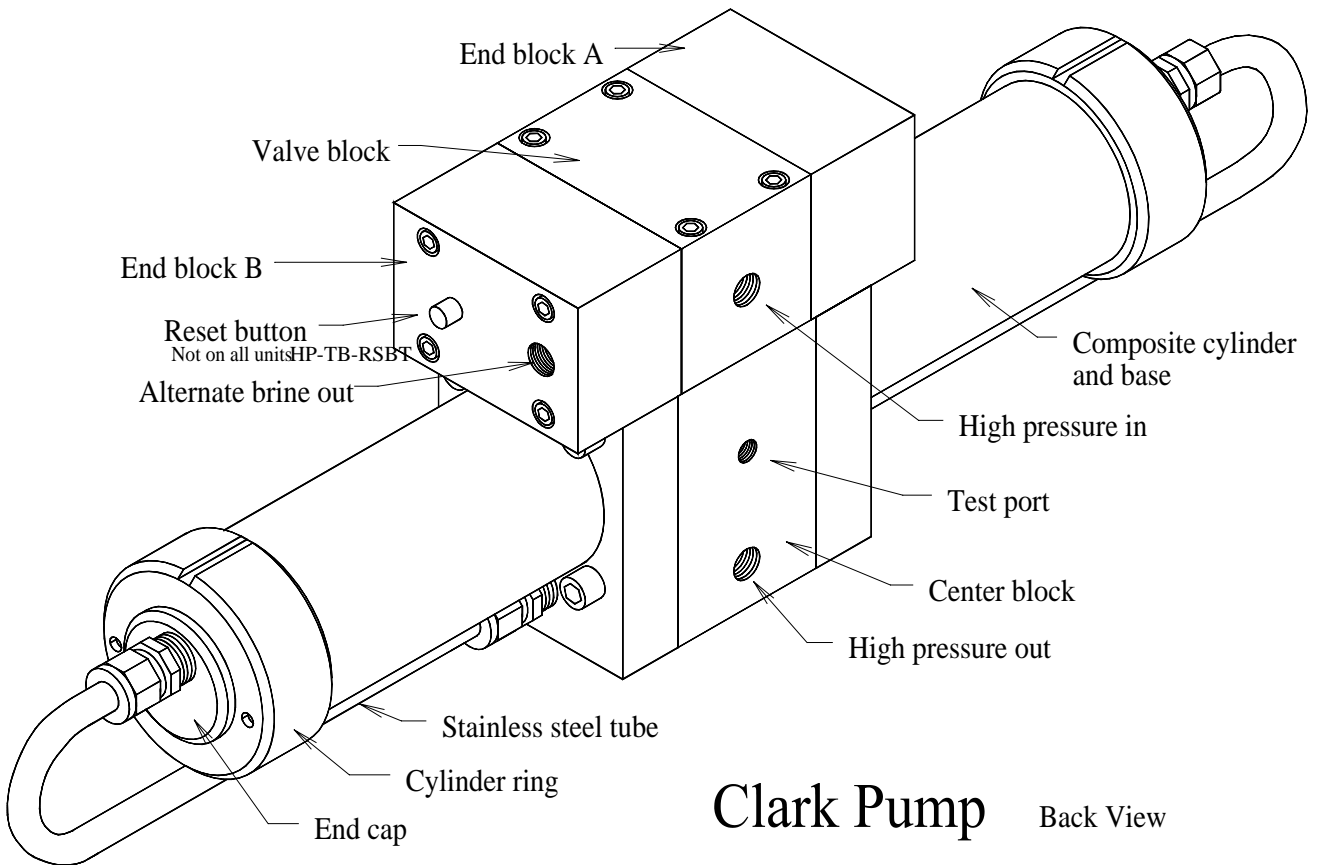

**Clark Pump** Back View

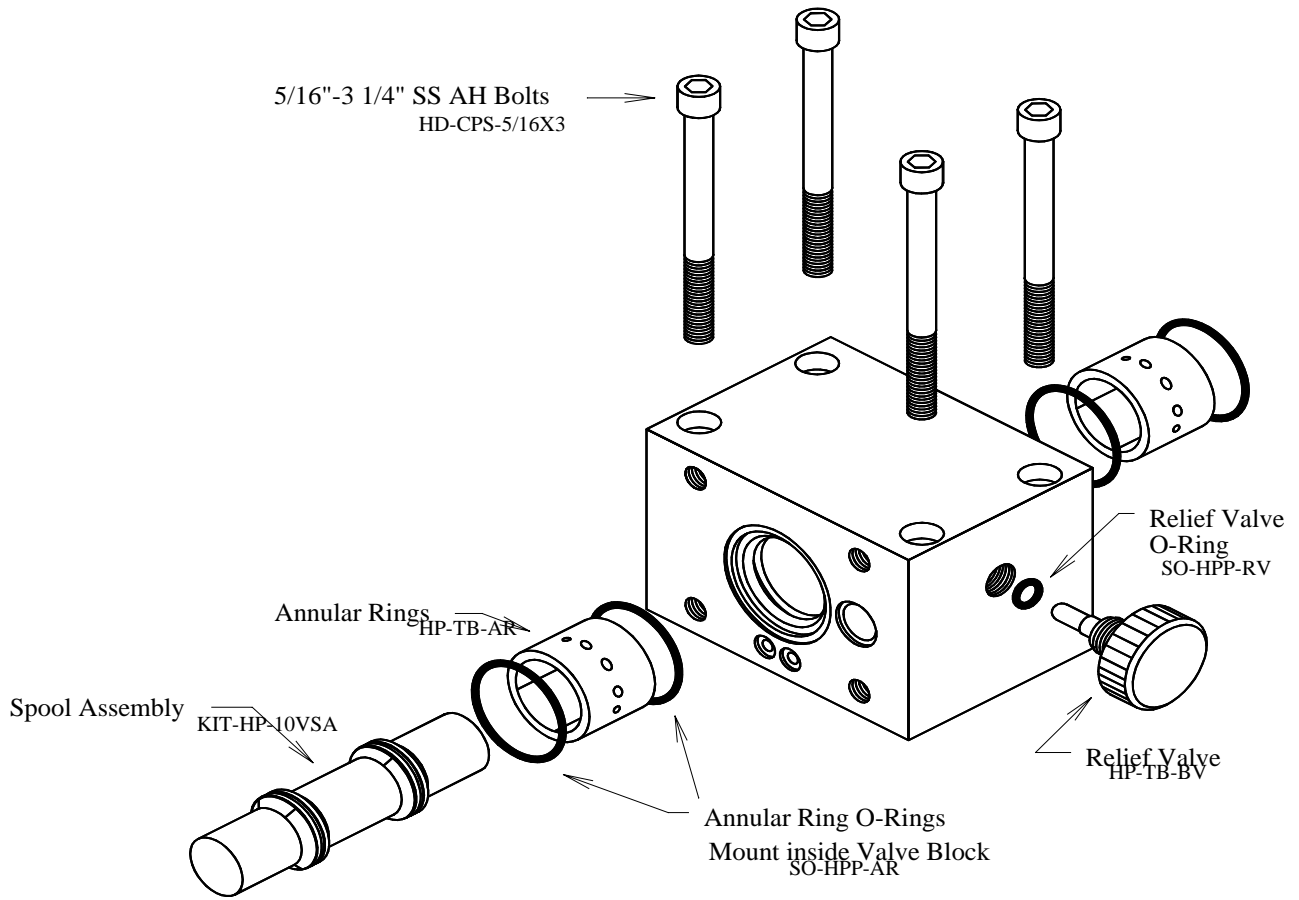

## Valve Block

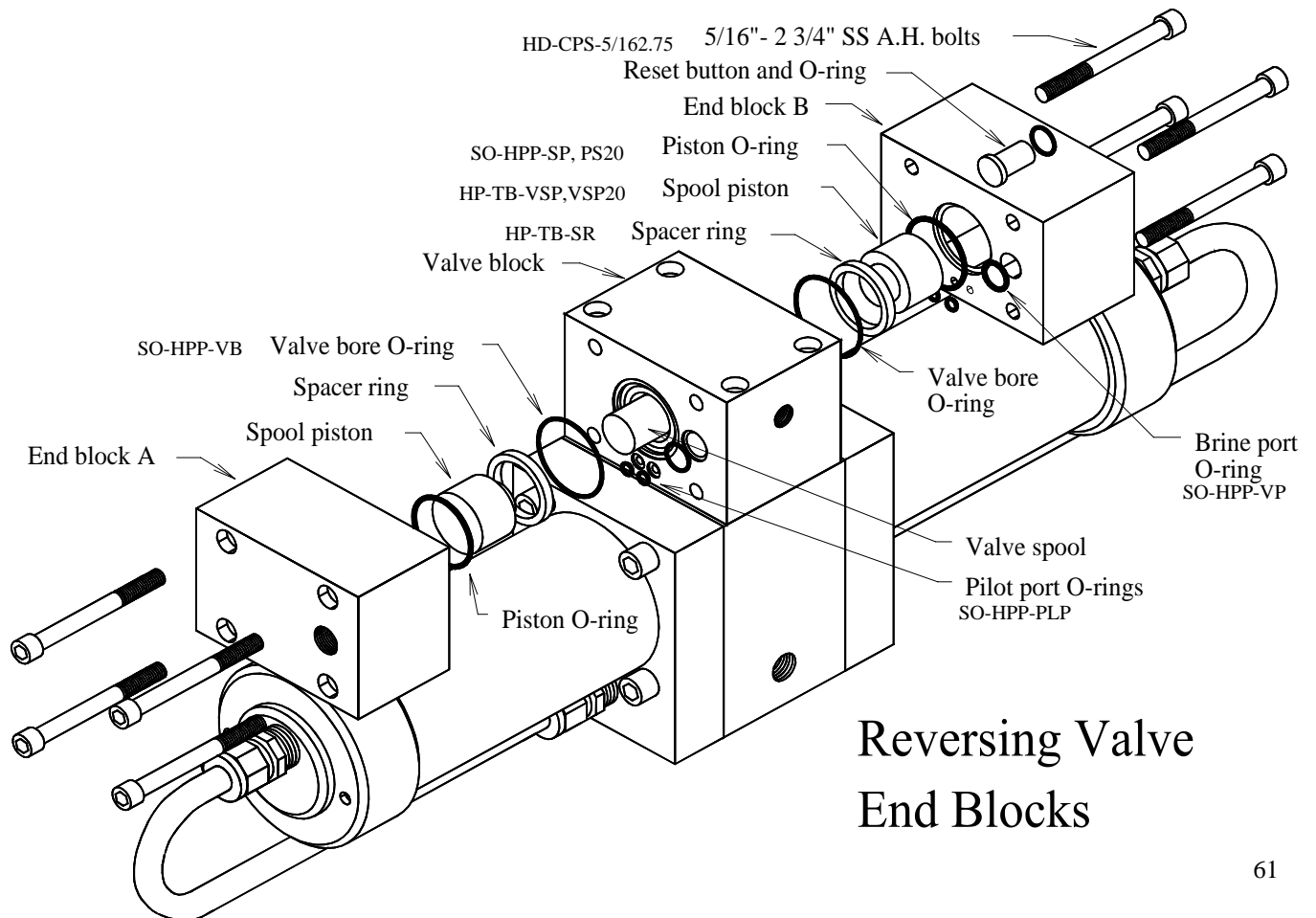

## Reversing Valve End Blocks

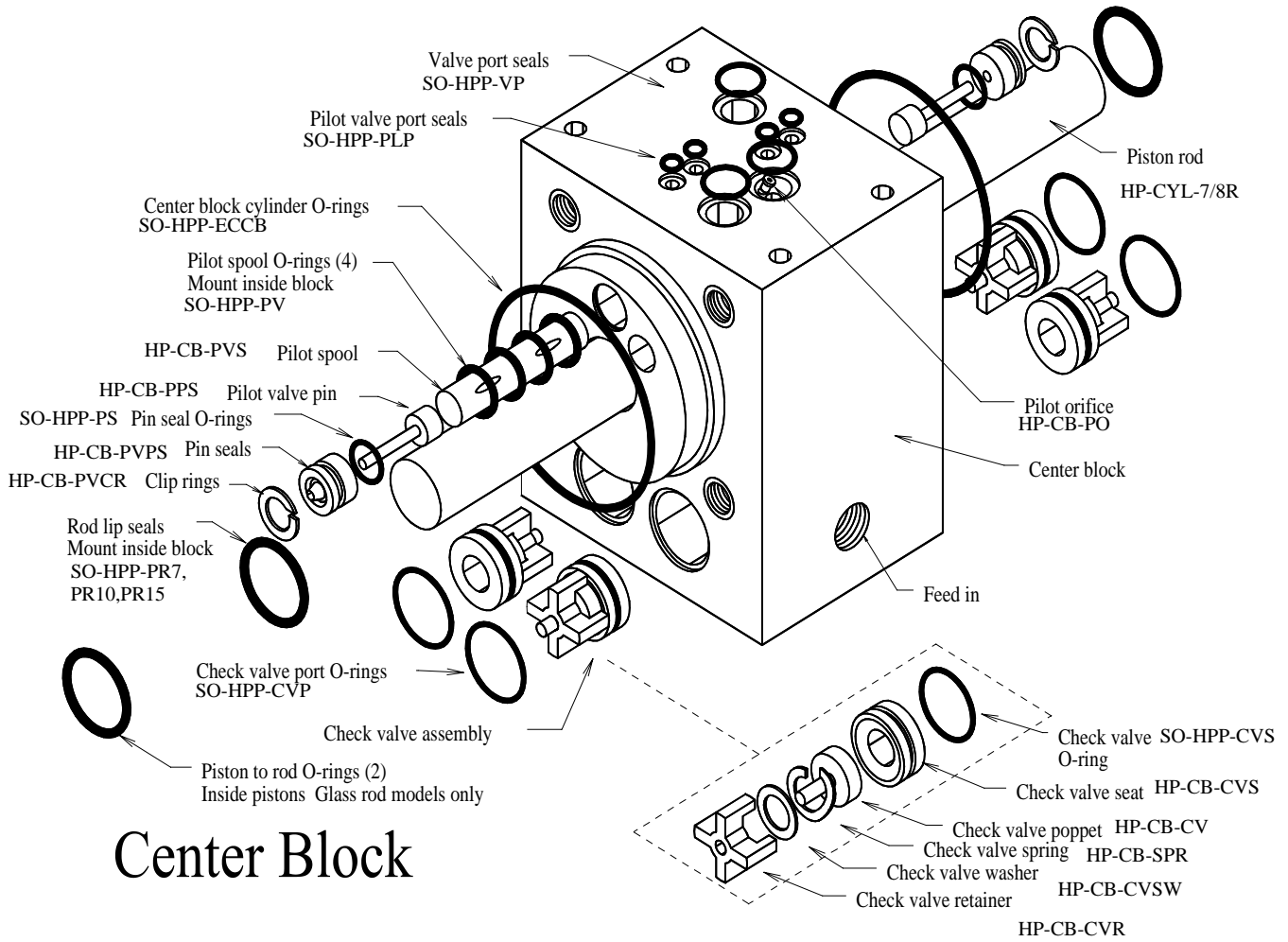

# Center Block

