

AC Tech

a member of the **Lenze** Group

Drive for Global Excellence



SCL/SCM Series Installation and Operation Manual

TABLE OF CONTENTS

1.0	GENERAL	1
2.0	SCL/SCM DIMENSIONS	3
3.0	SCL/SCM MODEL DESIGNATION CODE	5
4.0	SCL/SCM SPECIFICATIONS	5
5.0	SCL/SCM RATINGS	6
6.0	INSTALLATION	7
7.0	INPUT AC POWER REQUIREMENTS	8
8.0	POWER WIRING	11
9.0	SCL/SCM POWER WIRING DIAGRAM	12
10.0	CONTROL WIRING	13
11.0	SCL/SCM CONTROL WIRING DIAGRAMS	16
12.0	INITIAL POWER UP AND MOTOR ROTATION	20
13.0	PROGRAMMING THE SCL/SCM DRIVE	22
14.0	PARAMETER MENU	26
15.0	DESCRIPTION OF PARAMETERS	29
16.0	TROUBLESHOOTING	43
17.0	SCL/SCM DISPLAY MESSAGES	45

THE SCL/SCM SUB-MICRO DRIVE

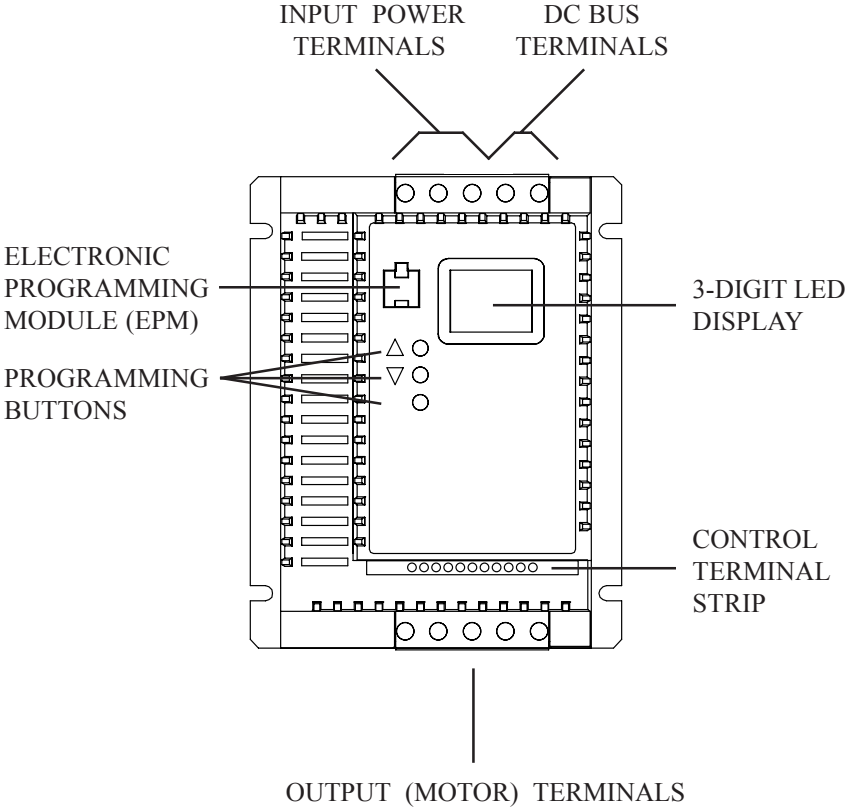

1.0 GENERAL

1.1 PRODUCTS COVERED IN THIS MANUAL

This manual covers the AC Tech SCL and SCM Series Variable Frequency Drive.

1.2 PRODUCT CHANGES

AC Technology Corporation reserves the right to discontinue or make modifications to the design of its products without prior notice, and holds no obligation to make modifications to products sold previously. AC Technology Corporation also holds no liability for losses of any kind which may result from this action. Instruction manuals with the most up-to-date information are available for download from the AC Tech website (www.actechdrives.com).

1.3 WARRANTY

AC Technology Corporation warrants the SCL/SCM Series AC motor control to be free of defects in material and workmanship for a period of twelve months from the date of sale to the user, or eighteen months from the date of shipment, whichever ever occurs first. If an SCL/SCM motor control, under normal use, becomes defective within the stated warranty time period, contact AC Technology's Service Department for instructions on obtaining a warranty replacement unit. AC Technology Corporation reserves the right to make the final determination as to the validity of a warranty claim, and sole obligation is to repair or replace only components which have been rendered defective due to faulty material or workmanship. No warranty claim will be accepted for components which have been damaged due to mishandling, improper installation, unauthorized repair and/or alteration of the product, operation in excess of design specifications or other misuse, or improper maintenance. AC Technology Corporation makes no warranty that its products are compatible with any other equipment, or to any specific application, to which they may be applied and shall not be held liable for any other consequential damage or injury arising from the use of its products.

This warranty is in lieu of all other warranties, expressed or implied. No other person, firm or corporation is authorized to assume, for AC Technology Corporation, any other liability in connection with the demonstration or sale of its products.

1.4 RECEIVING

Inspect all cartons for damage which may have occurred during shipping. Carefully unpack equipment and inspect thoroughly for damage or shortage. Report any damage to carrier and/or shortages to supplier. All major components and connections should be examined for damage and tightness, with special attention given to PC boards, plugs, knobs and switches.

1.5 SAFETY INFORMATION

GENERAL

All operations concerning installation and commissioning, as well as maintenance, must be carried out by qualified, skilled personnel (IEC 364 and CENELEC HD 384 or DIN VDE 0100 and IEC report 664 or DIN VDE 0110 and national regulations for the prevention of accidents must be observed).

According to this basic safety information, qualified skilled personnel are persons who are familiar with the installation, assembly, commissioning, and operation of the product and who have the qualifications necessary for their occupation.

APPLICATION AS DIRECTED

Drive controllers are components which are designed for installation in electrical systems or machinery. They are not to be used as appliances. They are intended exclusively for professional and commercial purposes according to EN 61000-3-2.

When installing the drive controllers in machines, commissioning (i.e. the starting of operation as directed) is prohibited until it is proven that the machine complies with the regulations of the EC Directive 98/37/EC (Machinery Directive); EN 60204 must be observed. Commissioning (i.e. starting of operation as directed) is only allowed when there is compliance with the EMC Directive (89/336/EEC).

The drive controllers meet the requirements of the Low Voltage Directive 73/23/EEC. The harmonised standards of the series EN50178/DIN VDE 0160 apply to the controllers.

WARNING!

The availability of controllers is restricted according to EN 61800-3. These products can cause radio interference in residential areas. In this case, special measures can be necessary.

ELECTRICAL CONNECTION

When working on live drive controllers, applicable national regulations for the prevention of accidents (e.g. VBG 4) must be observed.

The electrical installation must be carried out according to the appropriate regulations (e.g. cable size, fuses, PE connection).

This manual contains information about installation in compliance with EMC (shielding, grounding, filters and cables). These notes must also be observed for CE-marked controllers. The manufacturer of the system or machine is responsible for compliance with the required limit values demanded by EMC legislation.

1.6 CUSTOMER MODIFICATION

AC Technology Corporation, its sales representatives and distributors, welcome the opportunity to assist our customers in applying our products. Many customizing options are available to aid in this function. AC Technology Corporation cannot assume responsibility for any modifications not authorized by its engineering department.

2.0 SCL/SCM DIMENSIONS

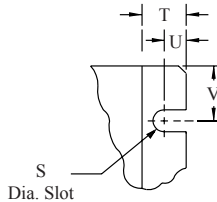
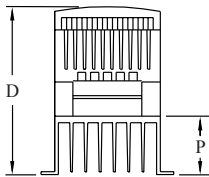
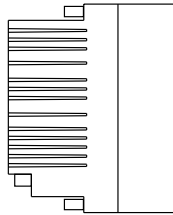
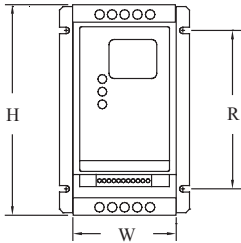

If $R < 6.30''$ (160)
 $S = 0.19''$ (5)
 $T = 0.38''$ (10)
 $U = 0.18''$ (5)
 $V = 0.66''$ (17)

If $R = 6.30''$ (160)
 $S = 0.28''$ (7)
 $T = 0.50''$ (13)
 $U = 0.24''$ (6)
 $V = 0.90''$ (23)

Mounting Tab Detail

KW (HP)	INPUT VOLTAGE	INPUT PHASE	SCM MODEL	SCL MODEL	H	W	D	P	R
0.25 (0.33)	120 208/240	1	SM004S	N/A	5.75 (146)	2.88 (74)	3.26 (83)	0.28 (7)	4.37 (111)
	120	1	SM005S	N/A	5.75 (146)	2.88 (74)	3.26 (83)	0.28 (7)	4.37 (111)
0.37 (0.5)	208/240	1	SM205S	SL205S	5.75 (146)	2.88 (74)	3.26 (83)	0.28 (7)	4.37 (111)
	208/240	3	SM205	N/A	5.75 (146)	2.88 (74)	3.26 (83)	0.28 (7)	4.37 (111)
	400/480	3	SM405	N/A	5.75 (146)	2.88 (74)	3.94 (100)	0.80 (20)	4.37 (111)
0.55 (0.75)	208/240	1	SM208S	SL208S	5.75 (146)	2.88 (74)	3.63 (92)	0.63 (16)	4.37 (111)
	120	1	SM010S	N/A	5.75 (146)	3.76 (95)	4.88 (124)	1.50 (38)	4.37 (111)
0.75 (1)	208/240	1	SM210S	SL210S	5.75 (146)	2.88 (74)	3.63 (92)	0.63 (16)	4.37 (111)
	208/240	3	SM210	N/A	5.75 (146)	2.88 (74)	3.63 (92)	0.63 (16)	4.37 (111)
	400/480	3	SM410	N/A	5.75 (146)	2.88 (74)	4.74 (120)	1.60 (41)	4.37 (111)
	120	1	SM015S	N/A	5.75 (146)	3.76 (95)	4.88 (124)	1.50 (38)	4.37 (111)
1.1 (1.5)	208/240	1	SM215S	SL215S	5.75 (146)	3.76 (95)	4.88 (124)	1.50 (38)	4.37 (111)
	208/240	3	SM215	N/A	5.75 (146)	2.88 (74)	5.56 (141)	2.56 (65)	4.37 (111)
	400/480	3	SM415	N/A	5.75 (146)	2.88 (74)	5.74 (146)	2.56 (65)	4.37 (111)

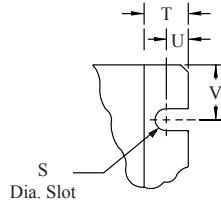
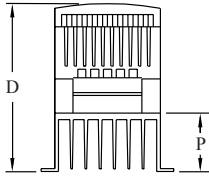
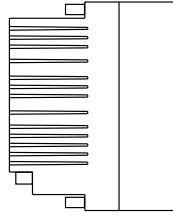
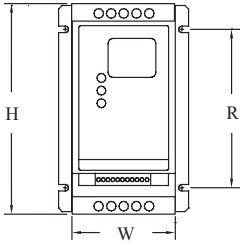

If R < 6.30" (160)
 S = 0.19" (5)
 T = 0.38" (10)
 U = 0.18" (5)
 V = 0.66" (17)

If R = 6.30" (160)
 S = 0.28" (7)
 T = 0.50" (13)
 U = 0.24" (6)
 V = 0.90" (23)

Mounting Tab Detail

KW (HP)	INPUT VOLTAGE	INPUT PHASE	SCM MODEL	SCL MODEL	H	W	D	P	R
1.5 (2)	208 / 240	1	SM220S	SL220S	5.75 (146)	3.76 (95)	4.88 (124)	1.50 (38)	4.37 (111)
	208 / 240	3	SM220	N / A	5.75 (146)	2.88 (74)	5.56 (141)	2.56 (65)	4.37 (111)
	400 / 480	3	SM420	N / A	5.75 (146)	2.88 (74)	5.74 (146)	2.56 (65)	4.37 (111)
2.2 (3)	208 / 240	1	SM230S	SL230S	5.75 (146)	3.76 (95)	5.53 (140)	2.18 (55)	4.37 (111)
	208 / 240	3	SM230	N / A	5.75 (146)	3.76 (95)	5.53 (140)	2.18 (55)	4.37 (111)
	400 / 480	3	SM430	N / A	5.75 (146)	3.76 (95)	5.24 (133)	1.90 (48)	4.37 (111)
4.0 (5)	208 / 240	3	SM250	N / A	5.75 (146)	3.76 (95)	6.74 (171)	3.40 (86)	3.25 (83)
	400 / 480	3	SM450	N / A	5.75 (146)	3.76 (95)	6.74 (171)	3.40 (86)	3.25 (83)
5.5 (7.5)	208 / 240	3	SM275	N / A	7.75 (197)	3.76 (95)	6.74 (171)	3.40 (86)	3.25 (83)
	400 / 480	3	SM475	N / A	5.75 (146)	3.76 (95)	6.74 (171)	3.40 (86)	3.25 (83)
7.5 (10)	208 / 240	3	SM2100	N / A	7.75 (197)	5.02 (128)	7.18 (182)	3.40 (86)	4.81 (122)
	400 / 480	3	SM4100	N / A	7.75 (197)	5.02 (128)	7.18 (182)	3.40 (86)	4.81 (122)
11 (15)	208 / 240	3	SM2150	N / A	9.75 (248)	6.68 (170)	8.00 (203)	3.40 (86)	6.30 (160)
	400 / 480	3	SM4150	N / A	7.75 (197)	5.02 (128)	7.18 (182)	3.60 (91)	4.81 (122)

3.0 SCL/SCM MODEL DESIGNATION CODE

The SCL/SCM model number gives a full description of the basic drive unit (see example below).

EXAMPLE: SL210S (SCL Series, 208/240 Vac, 1 HP, single phase input)

	SL	2	10	S
Series:				
SL = SCL Series Variable Speed AC Motor Drive with integral line filter				
SM = SCM Series Variable Speed AC Motor Drive				
Input Voltage:				
0 = 120 Vac (For 110, 115, and 120 Vac; 50 or 60 Hz)				
2 = 208/240 Vac (For 208, 220, 230, and 240 Vac; 50 or 60 Hz)				
4 = 400/480 Vac (For 380, 415, 460, and 480 Vac; 50 or 60 Hz)				
Rating:				
4 = 0.33 Hp (0.25 kW)		15 = 1.5 Hp (1.1 kW)		75 = 7.5 Hp (5.5 kW)
5 = 0.50 Hp (0.37 kW)		20 = 2 Hp (1.5 kW)		100 = 10 Hp (7.5 kW)
8 = 0.75 Hp (0.55 kW)		30 = 3 Hp (2.2 kW)		150 = 15 Hp (11 kW)
10 = 1 Hp (0.75 kW)		50 = 5 Hp (4.0 kW)		
Input Phase:				
S = Single phase input only.				
<i>No character indicates three phase input only</i>				

4.0 SCL/SCM SPECIFICATIONS

Storage Temperature	-20° to 70° C
Ambient Operating Temperature	0° to 40° C (up to 8 kHz carrier, derate above 8 kHz)
Ambient Humidity	< 95% (non-condensing)
Altitude	3300 ft (1000 m) above sea level (without derating)
Input Line Voltages	120, 208/240, 400/480 Vac
Input Voltage Tolerance	+10%, -15%
Input Frequency Tolerance	48 to 62 Hz
Output Wave Form	Sine Coded PWM
Output Frequency	0 - 240 Hz
Carrier Frequency	4 kHz to 10 kHz
Service Factor	1.00 (up to 6 kHz carrier, derate above 6 kHz)
Efficiency	Up to 98%
Power Factor (displacement)	0.96 or better
Overload Current Capacity	150% for 60 seconds, 180% for 30 seconds
Speed Reference Follower	0-10 VDC, 4-20 mA
Digital Outputs	(1) Normally open relay; contacts rated 3 amps at 250 Vac (1) Digital output (current-sourcing); rated 50 mA at 12 VDC
Earth Leakage Current (EN 50178)	SCL: > 3.5 mA to PE SCM: < 3.5 mA to PE

5.0 SCL/SCM RATINGS

SCM MODEL NUMBER (NOTE 1)	SCL MODEL NUMBER (NOTE 1)	FOR MOTORS RATED		INPUT (50 - 60 Hz)			OUTPUT (3 phase)	HEAT LOSS
		HP	KW	INPUT PHASE	CURRENT (AMPS)	POWER (KVA)	CURRENT (AMPS)	(WATTS) (NOTE 2)
120 Vac INPUT MODELS				120 Vac			0 - 230 Vac	
SM004S	N / A	0.33	0.25	1	6.8	0.8	1.7	29
SM005S	N / A	0.50	0.37	1	9.2	1.1	2.4	33
SM010S	N / A	1	0.75	1	16.6	2.0	4.2	57
SM015S	N / A	1.5	1.1	1	24	2.9	6.0	86
208 / 240 Vac INPUT MODELS				208 / 240 Vac			0 - 208 / 230 Vac	
SM204S	SL204S	0.33	0.25	1	3.9/3.4	0.8	1.9/1.7	23
SM205S	SL205S	0.50	0.37	1	5.8/5.0	1.2	2.8/2.4	31
SM205	N / A	0.50	0.37	3	3.1/2.7	1.1	2.8/2.4	31
SM208S	SL208S	0.75	0.55	1	6.9/6.0	1.4	3.7/3.2	34
SM210S	SL210S	1	0.75	1	10.6/9.2	2.2	4.8/4.2	47
SM210	N / A	1	0.75	3	5.8/5.1	2.1	4.8/4.2	47
SM215S	SL215S	1.5	1.1	1	13.9/12.0	2.9	6.9/6.0	68
SM215	N / A	1.5	1.1	3	8.0/6.9	2.9	6.9/6.0	68
SM220S	SL220S	2	1.5	1	18.4/16.0	3.1	8.1/7.0	71
SM220	N / A	2	1.5	3	9.1/7.9	3.3	8.1/7.0	71
SM230S	SL230S	3	2.2	1	24/21	4.1	11.0/9.6	108
SM230	N / A	3	2.2	3	12.4/10.8	4.5	11.0/9.6	108
SM250	N / A	5	4.0	3	19.6/17.1	7.1	17.5/15.2	173
SM275	N / A	7.5	5.5	3	28/25	10.3	25/22	286
SM2100	N / A	10	7.5	3	34/32	13.1	30/28	379
SM2150	N / A	15	11	3	54/48	20.0	48/42	476
400 / 480 Vac INPUT MODELS				400 / 480 Vac			0 - 400 / 460 Vac	
SM405	N / A	0.50	0.37	3	1.6/1.4	1.1	1.3/1.1	31
SM410	N / A	1	0.75	3	3.0/2.5	2.1	2.5/2.1	47
SM415	N / A	1.5	1.1	3	4.3/3.6	3.0	3.6/3.0	58
SM420	N / A	2	1.5	3	4.8/4.0	3.3	4.1/3.4	63
SM430	N / A	3	2.2	3	6.4/5.4	4.5	5.8/4.8	92
SM450	N / A	5	4.0	3	10.6/8.8	7.1	9.4/7.8	155
SM475	N / A	7.5	5.5	3	14.2/12.4	10.3	12.6/11.0	254
SM4100	N / A	10	7.5	3	18.1/15.8	13.1	16.1/14.0	310
SM4150	N / A	15	11	3	27/24	20.0	24/21	390

NOTE 1: See Section 3.0 for model number breakdown.

NOTE 2: Values are worst-case (not typical) for 6kHz carrier frequency at full speed and full load.

6.0 INSTALLATION

NOTE!

SCL/SCM Series drives are intended for inclusion within other equipment, by professional electrical installers according to EN 61000-3-2. They are not intended for stand-alone operation.

WARNING!

DRIVES MUST NOT BE INSTALLED WHERE SUBJECTED TO ADVERSE ENVIRONMENTAL CONDITIONS SUCH AS: COMBUSTIBLE, OILY, OR HAZARDOUS VAPORS OR DUST; EXCESSIVE MOISTURE OR DIRT; VIBRATION; EXCESSIVE AMBIENT TEMPERATURES. CONSULT AC TECHNOLOGY FOR MORE INFORMATION ON THE SUITABILITY OF A DRIVE TO A PARTICULAR ENVIRONMENT.

SCL/SCM models are suitable for UL pollution degree 2 environment only, and **MUST** be installed in an electrical enclosure which will provide complete mechanical protection and will maintain the internal temperature within the drive's ambient operating temperature rating. All drive models **MUST** be mounted in a vertical position for proper heatsink cooling.

Maintain a minimum spacing around the drive of at least 1 inch (25 mm) on each side and 2 inches (50 mm) on the top and bottom for units up to 5 Hp (4 kW), and 2 inches (50 mm) on each side and 4 inches (100 mm) on the top and bottom for larger units. Allow more spacing if the drive is mounted next to other heat-producing equipment. Do not mount drives above other drives or heat producing equipment. Fans or blowers should be used to insure proper cooling in tight quarters.

In order to properly size an enclosure, the heat generated by the drive(s) must be known. Refer to the HEAT LOSS column in Section 5.0 - SCL/SCM RATINGS. An enclosure manufacturer can then determine the required enclosure size based on the total heat generated inside the enclosure (from the drive(s) and other heat sources), the maximum allowable temperature inside the enclosure, the maximum ambient temperature outside the enclosure, and the enclosure properties.

The SCL/SCM Series is UL approved for solid state motor overload protection. Therefore, a separate thermal overload relay is not required for single motor applications.

6.1 INSTALLATION AFTER A LONG PERIOD OF STORAGE

WARNING!

Severe damage to the drive can result if it is operated after a long period of storage or inactivity without reforming the DC bus capacitors!

If input power has not been applied to the drive for a period of time exceeding three years (due to storage, etc), the electrolytic DC bus capacitors within the drive can change internally, resulting in excessive leakage current. This can result in premature failure of the capacitors if the drive is operated after such a long period of inactivity or storage.

In order to reform the capacitors and prepare the drive for operation after a long period of inactivity, apply input power to the drive for 8 hours prior to actually operating the motor.

7.0 INPUT AC POWER REQUIREMENTS

WARNING!

Hazard of electrical shock! Capacitors retain charge after power is removed. Disconnect incoming power and wait until the voltage between terminals B+ and B- is 0 VDC before servicing the drive.

The input voltage must match the nameplate voltage rating of the drive. Voltage fluctuation must not vary by greater than 10% overvoltage or 15% undervoltage.

NOTE: Drives with dual input voltage ratings must be programmed for the proper supply voltage (refer to Parameter 01 - LINE VOLTAGE SELECTION in Section 15.0 - DESCRIPTION OF PARAMETERS).

The drive is suitable for use on a circuit capable of delivering not more than 5,000 RMS symmetrical amperes at the drive's rated voltage.

If the kVA rating of the AC supply transformer is greater than 10 times the input kVA rating of the drive(s), an isolation transformer, or 2-3% input line reactor must be added to the line side of the drive(s).

Three phase voltage imbalance must be less than 2.0% phase to phase. Excessive phase to phase imbalance can cause severe damage to the drive.

Motor voltage should match line voltage in normal applications. The drive's maximum output voltage will equal the input voltage. Use extreme caution when using a motor with a voltage rating which is different from the input line voltage.

7.1 INPUT VOLTAGE RATINGS

SM000S Series drives are rated for 120 Vac single phase, 50-60 Hz input. The drive will function with input voltage of 120 Vac (+10%, -15%) at 48 to 62 Hz.

SM200S & SL200S Series drives are rated for 208/240 Vac, single phase, 50-60 Hz input. The drive will function with input voltage of 208 to 240 Vac (+10%, -15%), at 48 to 62 Hz.

SM200 Series drives are rated for 208/240 Vac, three phase, 50-60 Hz input. The drive will function with input voltage of 208 to 240 Vac (+10%, -15%) at 48 to 62 Hz.

SM400 Series drives are rated for 400/480 Vac, three phase, 50-60 Hz input. The drive will function with input voltage of 400 to 480 Vac (+10%, -15%) at 48 to 62 Hz.

NOTE: Parameter 01 - LINE VOLTAGE SELECTION must be programmed according to the applied input voltage. See Section 15.0 - DESCRIPTION OF PARAMETERS.

7.2 INPUT FUSING AND DISCONNECT REQUIREMENTS

A circuit breaker or a disconnect switch with fuses must be provided in accordance with the National Electric Code (NEC) and all local codes. Refer to the following tables for proper ratings:

INPUT FUSE & CIRCUIT BREAKER RATINGS (for installation to UL and EN 60204-1)							
120 Vac 1 phase		208/240 Vac 1 phase		208/240 Vac 3 phase		400/480 Vac 3 phase	
SM004S	10 A	S_204S	10 A				
SM005S	15 A	S_205S	10 A	SM205	10 A	SM405	10 A
		S_208S	10 A				
SM010S	25 A	S_210S	15 A	SM210	10 A	SM410	10 A
SM015S	35 A	S_215S	20 A	SM215	12 / 10 A	SM415	10 A
		S_220S	25 / 20 A	SM220	15 / 12 A	SM420	10 A
		S_230S	30 / 25 A	SM230	20 / 15 A	SM430	10 A
				SM250	30 / 25 A	SM450	15 / 12 A
				SM275	45 / 40 A	SM475	20 / 20 A
				SM2100	50 / 50 A	SM4100	30 / 25 A
				SM2150	80 / 75 A	SM4150	40 / 35 A

NOTE 1: Use UL Class CC fast-acting, current limiting type fuses. Select fuses with low I²T values, rated at 200,000 AIC. Recommended fuses are Bussman KTK-R, JLN, and JJS. Similar fuses with equivalent ratings by other manufacturers may also be acceptable.

NOTE 2: When using a pulse-current or universal-current sensitive ELCB (earth leakage circuit breaker), the detection level must be rated 30mA or greater. Observe the following when using ELCBs:
1. Only install the ELCB between the supply mains and drive controller.

2. The ELCB can be activated by:

- capacitive leakage currents between the cable screens during operation (especially with long, screened motor cables)
- connecting several drives to the mains at the same time
- additional RFI filters

WIRE SIZE REQUIREMENTS (for installation to UL and EN 60204-1)											
120 Vac 1 phase			208/240 Vac 1 phase			208/240 Vac 3 phase			400/480 Vac 3 phase		
MODEL	AWG	mm ²	MODEL	AWG	mm ²	MODEL	AWG	mm ²	MODEL	AWG	mm ²
SM004S	14	1.5	S_204S	14	1.5						
SM005S	14	2.5	S_205S	14	1.5	SM205	14	1.5	SM405	14	1.5
			S_208S	14	1.5						
SM010S	12	4.0	S_210S	14	2.5	SM210	14	1.5	SM410	14	1.5
SM015S	10	4.0	S_215S	14	2.5	SM215	14	1.5	SM415	14	1.5
			S_220S	12	4.0	SM220	14	2.5	SM420	14	1.5
			S_230S	10	4.0	SM230	14	2.5	SM430	14	1.5
						SM250	12	4.0	SM450	14	2.5
						SM275	8	6.0	SM475	12	2.5
						SM2100	8	10	SM4100	10	4.0
						SM2150	6	16	SM4150	8	6.0

7.3 INSTALLATION ACCORDING TO EMC REQUIREMENTS

The SCM and SCL Series can be installed to meet the European standards for Electromagnetic Compatibility (EMC) requirements. These requirements govern the permissible electromagnetic emissions and immunity, both radiated and conducted, of a drive system.

The EMC requirements apply to the final installation in its entirety, not to the individual components used. Because every installation is different, the recommended installation should follow these guidelines as a minimum. Additional equipment (such as ferrite core absorbers on power conductors) or alternative wiring practices may be required to meet conformance in some installations.

Filter: The input to the drive (or group of drives) must include a filter to reduce the electrical noise reflected back to the AC Line. The SCL Series includes a filter that has been tested to meet the industrial standards set by the EU, EN 61800-3 for conducted emissions and EN 55011 for radiated emissions to class A compliance when installed in a control cabinet with a motor cable < 10m. The SCM can be installed to meet these same standards when used with an appropriately installed external line filter.

Installation: Shielded cable must be used for all control and power cables and exposed wiring must be kept as short as possible. The figure to the right shows the control cable (B) and motor cable (C) with the shield grounded with clamps (A) to a grounded, electrically conductive mounting panel (D). The motor cable must be of a low capacitance specification:

$$\text{core/core} < 75 \text{ pF/m, core/shield} < 150 \text{ pF/m}$$

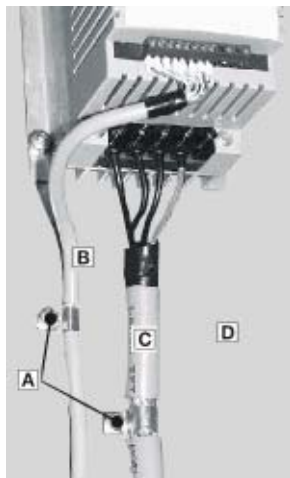

8.0 POWER WIRING

WARNING!

Hazard of electrical shock! Capacitors retain charge after power is removed. Disconnect incoming power and wait until the voltage between terminals B+ and B- is 0 VDC before servicing the drive.

Note drive input and output current ratings and check applicable electrical codes for required wire type and size, grounding requirements, over-current protection, and incoming power disconnect, before wiring the drive. Size conservatively to minimize voltage drop.

Input fusing and a power disconnect switch or contactor **MUST** be wired in series with terminals L1 and L2/N (on single-phase input models), or terminals L1, L2, and L3 (on three-phase input models). This disconnect must be used to power down the drive when servicing, or when the drive is not to be operated for a long period of time, but should not be used to start and stop the motor.

Repetitive cycling of a disconnect or input contactor (more than once every two minutes) may cause damage to the drive.

8.1 INPUT AND OUTPUT WIRING

On single phase input models, wire the input power to terminals L1 and L2/N. On three phase input models, wire the input power to terminals L1, L2, and L3. Refer to Section 9.0 - SCL/SCM POWER WIRING DIAGRAM.

All three power output wires, from terminals U, V, and W to the motor, must be kept tightly bundled and run in a separate conduit away from all other power and control wiring.

It is not recommended to install contactors or disconnect switches between the drive and motor. Operating such devices while the drive is running can potentially cause damage to the drive's power components. If such a device is required, it should only be operated when the drive is in a STOP state. If there is potential for the device to be opened while the drive is running, the drive must be programmed for COAST to stop (see Parameter 4 - STOP METHOD), and an auxiliary contact on the device must be interlocked with the drive's run circuit. This will give the drive a stop command at the same time the device opens, and will not allow the drive to start again until the device is closed.

9.0 SCL/SCM POWER WIRING DIAGRAM

INPUT
(SINGLE-PHASE MODELS ONLY)

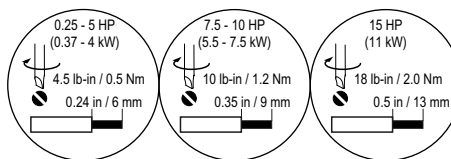
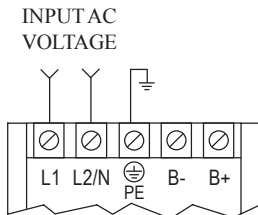

INPUT
(THREE-PHASE MODELS ONLY)

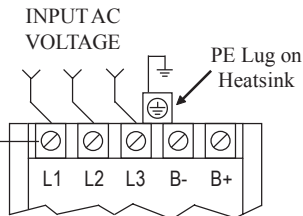

OUTPUT (ALL MODELS)

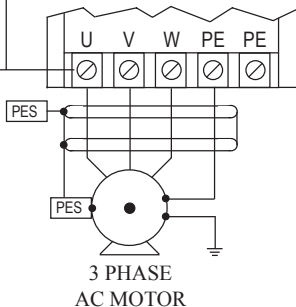

3 PHASE
AC MOTOR

WARNING!

DO NOT connect incoming AC power to output terminals U, V, W, or terminals B+, B-! Severe damage to the drive will result.

NOTES:

1. WIRE AND GROUND IN ACCORDANCE WITH NEC OR CEC, AND ALL APPLICABLE LOCAL CODES.
2. Motor wires MUST be run in a separate steel conduit away from control wiring and incoming AC power wiring.
3. Do not install contactors between the drive and the motor without consulting AC Technology for more information. Failure to do so may result in drive damage.
4. Use only UL and CSA listed and approved wire.
5. Minimum wire voltage rating is 300 V for 120, 208, and 240 Vac systems, and 600 V for 400 and 480 Vac systems.
6. Wire gauge must be based on a minimum of 125% of the rated input/output current of the drive, and a minimum 75°C insulation rating. Use copper wire only.
7. Strip off 0.20 to 0.25 inches (5 to 6 mm) of insulation for input power, output power, and DC Bus wiring.

10.0 CONTROL WIRING

10.1 CONTROL WIRING VS. POWER WIRING

External control wiring **MUST** be run in a separate conduit away from all other input and output power wiring. If control wiring is not kept separate from power wiring, electrical noise may be generated on the control wiring that will cause erratic drive behavior. Use twisted wires or shielded cable grounded at the drive chassis **ONLY**. Recommended control wire is Belden 8760 (2-wire) or 8770 (3-wire), or equivalent.

Strip off 0.20 to 0.25 inches (5 to 6 mm) of insulation for control wiring, and torque the control terminals to 2 lb-in (0.2 Nm). Be careful not to overtorque the control terminals, as this will cause damage to the terminal strip. This is not covered under warranty and can only be repaired by replacing the control board.

10.2 TB-2: CIRCUIT COMMON

The TB-2 terminal is used as circuit common for the analog speed reference inputs. If necessary TB-2 may be connected to chassis ground.

10.3 SURGE SUPPRESSION ON RELAYS

Current and voltage surges and spikes in the coils of contactors, relays, solenoids, etc, near or connected to the drive, can cause erratic drive operation. Therefore, a snubber circuit should be used on coils associated with the drive. For AC coils, snubbers should consist of a resistor and a capacitor in series across the coil. For DC coils, a free-wheeling or flyback diode should be placed across the coil. Snubbers are typically available from the manufacturer of the device.

10.4 START/STOP CONTROL

There are various control schemes that allow for 2-wire and 3-wire Start/Stop circuits. Refer to the wiring diagrams in Section 11.0 - SCL/SCM CONTROL WIRING DIAGRAMS

10.5 SPEED REFERENCE SIGNALS

The drive allows for three analog speed reference inputs:

SPEED POT Connect the wiper of a speed pot to terminal TB-5, and connect the high and low end leads to terminals TB-6 and TB-2, respectively. The speed pot can be 2.5k Ω up to 10k Ω .

0-10 VDC Wire the positive to terminal TB-5 and the negative to terminal TB-2. TB-5 input impedance is 120 kilohms.

4-20 mA Wire the positive to terminal TB-25 and the negative to terminal TB-2. TB-25 input impedance is 250 ohms.

10.6 SPEED REFERENCE SELECTION

If an analog speed reference input is used to control the drive speed, terminal TB-13A, 13B, or 13E (Parameter 10, 11, or 12) may be programmed as the input select for the desired analog input signal. When that TB-13 terminal is then closed to TB-11, the drive will follow the selected analog speed reference input.

If an analog speed reference input is not selected on the terminal strip using TB-13A, 13B, or 13E, speed control will default to STANDARD mode, which is governed by the setting of STANDARD SPEED SOURCE (Parameter 05). The STANDARD SPEED SOURCE can be the ▲ and ▼ buttons on the front of the drive, PRESET SPEED #1 (Parameter 31), a 0-10 VDC signal, or a 4-20 mA signal.

0 - 10 VDC and 4 - 20 mA INPUT SIGNALS

TB-13A, TB-13B, and TB-13E can all be programmed to select a 0-10 VDC or 4-20 mA analog speed reference input.

PRESET SPEEDS

TB-13A can be programmed to select PRESET SPEED #1 (04), TB-13B to select PRESET SPEED #2 (04), and TB-13E to select PRESET SPEED #3 (04). There are a total of seven preset speeds, which are activated by different combinations of contact closures between TB-13A, 13B, 13E and TB-11. Refer to Parameters 31-37 in Section 15.0 - DESCRIPTION OF PARAMETERS.

JOG

TB-13B can be programmed to select either JOG FORWARD (07) or JOG REVERSE (08). The Jog speed is set by PRESET SPEED #2 (Parameter 32). Close TB-13B to TB-11 to JOG, and open the contact to STOP.

WARNING!

When operating in JOG mode, the STOP signal and the AUXILIARY STOP function (see Parameters 10-12) **WILL NOT** stop the drive. To stop the drive, remove the JOG command.

JOG REVERSE will operate the drive in reverse rotation even if ROTATION DIRECTION (Parameter 17) is set to FORWARD ONLY.

NOTE: If the drive is commanded to JOG while running, the drive will enter JOG mode and run at PRESET SPEED #2. When the JOG command is removed, the drive will STOP.

MOTOR OPERATED POT (MOP) / FLOATING POINT CONTROL

TB-13B and TB-13E are used for this function, which controls the drive speed using contacts wired to the terminal strip. Program TB-13B for DECREASE FREQ (05), and program TB-13E for INCREASE FREQ (05). Closing TB-13B to TB-11 will cause the speed setpoint to decrease until the contact is opened. Closing TB-13E to TB-11 will cause the speed setpoint to increase until the contact is opened. The INCREASE FREQ function will only operate while the drive is running.

NOTE: If TB-13A, TB-13B, and TB-13E are all programmed to select speed references, and two or three of the terminals are closed to TB-11, the higher terminal has priority and will override the others. For example, if TB-13A is programmed to select 0-10VDC, and TB-13E is programmed to select PRESET SPEED #3, closing both terminals to TB-11 will cause the drive to respond to PRESET SPEED #3, because TB-13E overrides TB-13A.

The exception to this is the MOP function, which requires the use of TB-13B and TB-13E. This leaves TB-13A to be used for some other function. If TB-13A is programmed for a speed reference, and TB-13A is closed to TB-11, TB-13A will override the MOP function.

10.7 DRIVE STATUS DIGITAL OUTPUTS

There is one Form A relay at terminals TB-16 and TB-17. Relay contacts are rated 3 amps at 250 Vac.

Terminal TB-13E can also be configured as a digital output. This output circuit is a current-sourcing type rated at 12 VDC and 50 mA maximum.

The Form A relay and digital output can be programmed to indicate any of the following: RUN, FAULT, INVERSE FAULT, FAULT LOCKOUT, AT SPEED, ABOVE PRESET SPEED #3, CURRENT LIMIT, AUTO SPEED MODE, and REVERSE. Refer to Parameters 06 and 12 in Section 15.0 - DESCRIPTION OF PARAMETERS.

The diagram below illustrates how TB-13E, when configured as a digital output, can be used to drive an external relay:

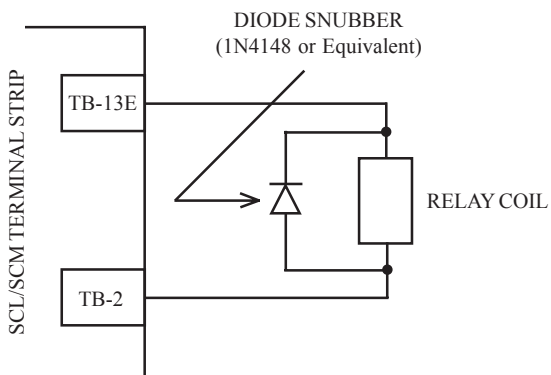

11.0 SCL/SCM CONTROL WIRING DIAGRAMS

11.1 SCL/SCM TERMINAL STRIP

Shown below is the control terminal strip, along with a brief description of the function of each terminal. The following wiring diagram examples provide a quick reference to wire the drive for the most common configurations.

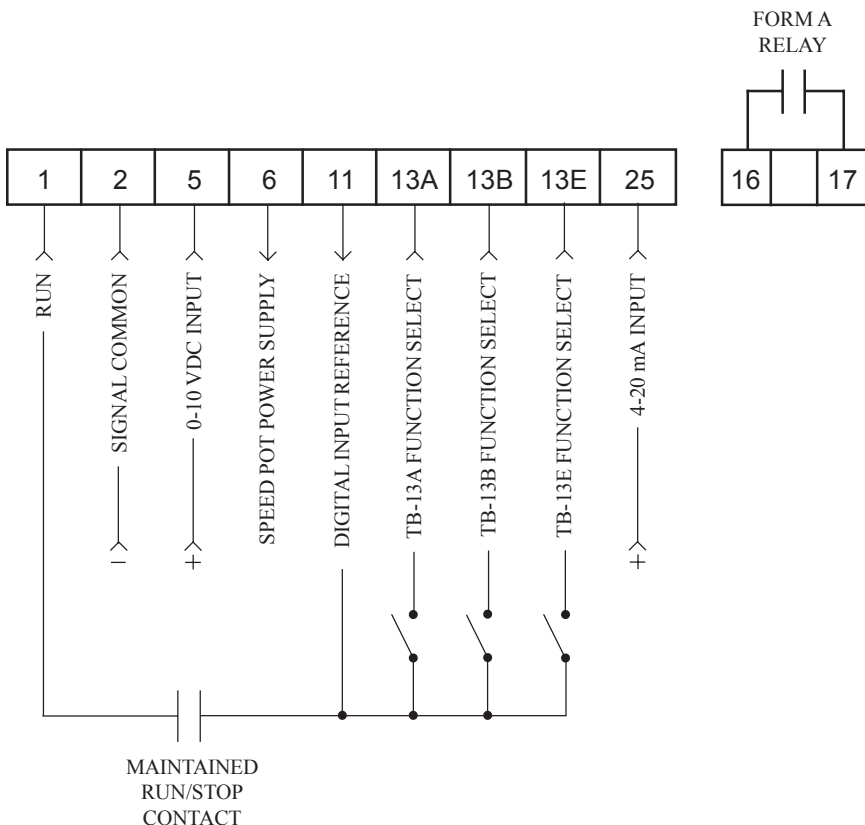

NOTE 1: The function of terminals TB-13A, 13B, 13E and the Form A relay at terminals 16 and 17 are dependent on the programming of certain parameters. Refer to Section 15.0 - DESCRIPTION OF PARAMETERS.

NOTE 2: The digital inputs (terminals 1, 13A, 13B, and 13E) are active-high. They can be activated using terminal 11 (which is +12 VDC) as shown in the following diagrams, or by using an external voltage source with a range of +12 VDC to +28 VDC ($\pm 10\%$).

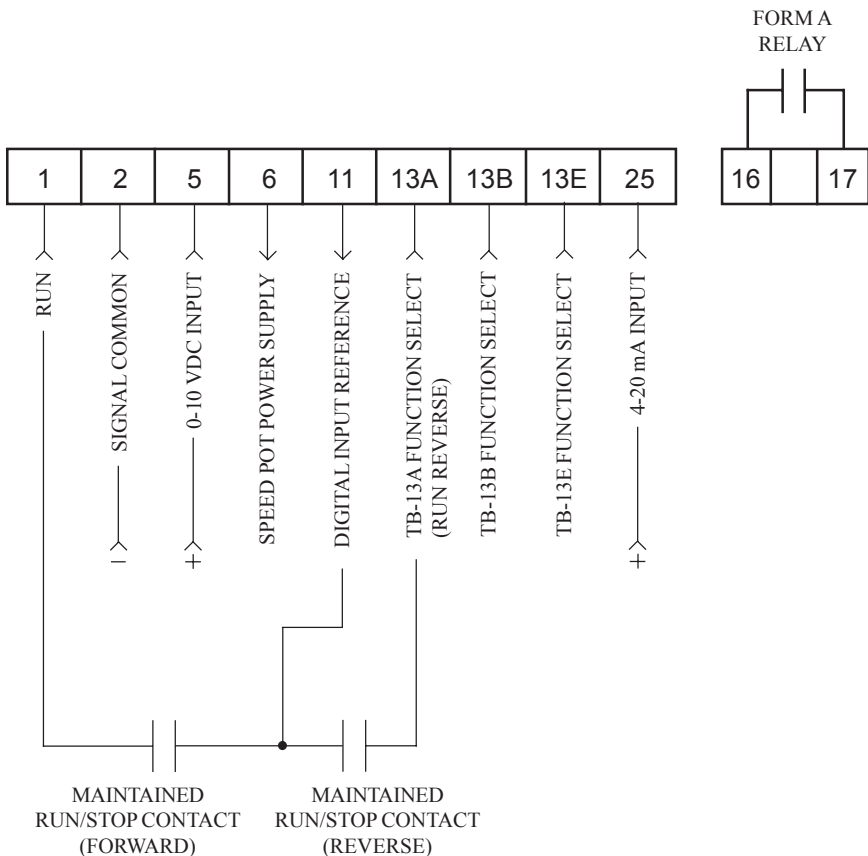

NOTES:

1. Close TB-1 to TB-11 to RUN, and open to STOP. TB-1 functions as a RUN input for two-wire start/stop circuits, and a STOP input for three-wire start/stop circuits. Refer to Section 11.3.
2. If reverse direction is required, set ROTATION (Parameter 17) to FORWARD AND REVERSE (02), and program TB-13A (Parameter 10) to RUN REVERSE (06). Close TB-13A to TB-11 to RUN in the reverse direction, and open to STOP.
3. For 0-10 VDC or 4-20 mA speed control, set STANDARD SPEED SOURCE (Parameter 05) to 0-10 VDC (03) or 4-20 mA (04).

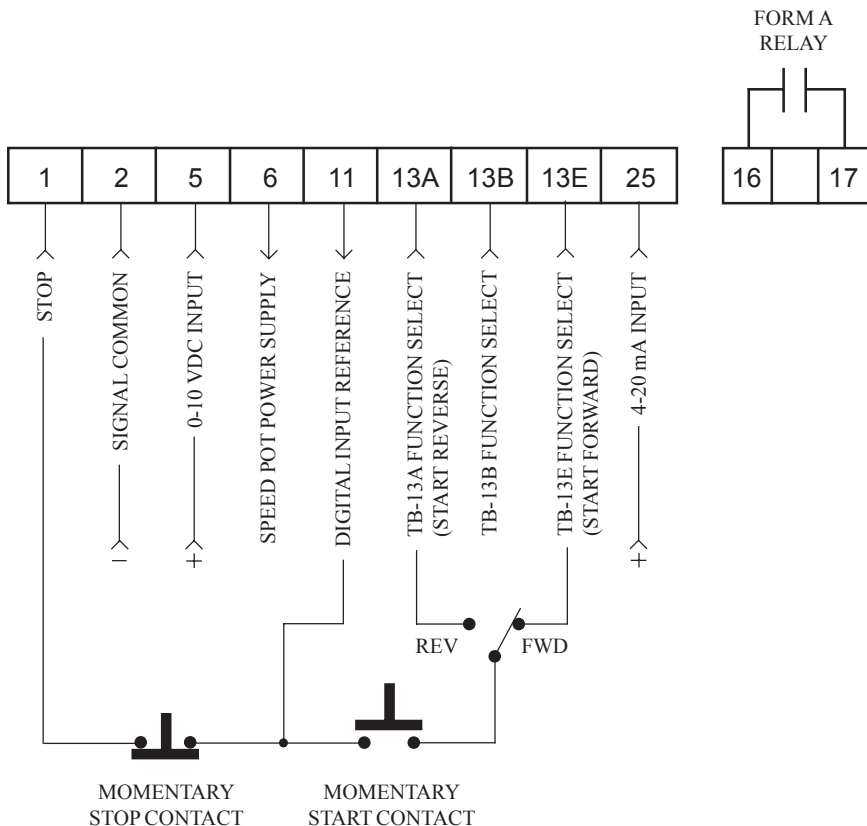

NOTES:

1. Program TB-13E (Parameter 12) for START FORWARD (06).
2. If reverse direction is required, set ROTATION (Parameter 17) to FORWARD AND REVERSE (02), and program TB-13A (Parameter 10) for START REVERSE (07).
3. Momentarily close TB-13E to TB-11 to START in the forward direction, or close TB-13A to TB-11 to START in the reverse direction. Momentarily open TB-1 to TB-11 to STOP the drive.
4. For 0-10 VDC or 4-20 mA speed control, set STANDARD SPEED SOURCE (Parameter 05) to 0-10 VDC (03) or 4-20 mA (04).

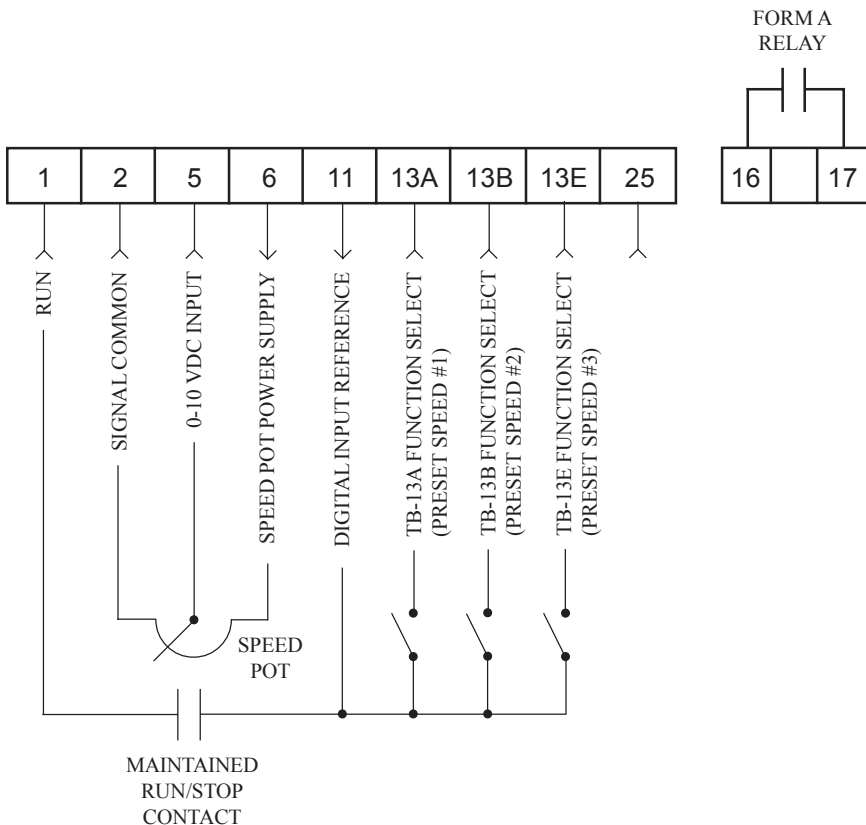

NOTES:

1. For preset speed control, all or some of the TB-13 terminals must be programmed as preset speed selects. If only two or three preset speeds are required, only two of the TB-13 terminals must be used. Refer to the table in the description of Parameters 31-37 in Section 15.0.
2. Program the PRESET SPEEDS (Parameters 31-37) to the desired values.
3. If speed pot control is desired when none of the preset speeds are selected (all preset speed selects are open to TB-11), set STANDARD SPEED SOURCE (Parameter 05) to 0-10 VDC (03).

12.0 INITIAL POWER UP AND MOTOR ROTATION

WARNING!

DO NOT connect incoming AC power to output terminals U, V, and W or terminals B+, B-! Severe damage to the drive will result. Do not continuously cycle input power to the drive more than once every two minutes. Damage to the drive will result.

WARNING!

Hazard of electrical shock! Wait three minutes after disconnecting incoming power before servicing drive. Capacitors retain charge after power is removed.

WARNING!

Severe damage to the drive can result if it is operated after a long period of storage or inactivity without reforming the DC bus capacitors!

If input power has not been applied to the drive for a period of time exceeding three years (due to storage, etc), the electrolytic DC bus capacitors within the drive can change internally, resulting in excessive leakage current. This can result in premature failure of the capacitors if the drive is operated after such a long period of inactivity or storage.

In order to reform the capacitors and prepare the drive for operation after a long period of inactivity, apply input power to the drive for 8 hours prior to actually operating the motor.

Before attempting to operate the drive, motor, and driven equipment, be sure all procedures pertaining to installation and wiring have been properly followed.

Disconnect the driven load from the motor. Verify that the drive input terminals (L1 and L2/N, or L1, L2, and L3) are wired to the proper input voltage per the nameplate rating of the drive.

Energize the incoming power line. The LED display will flash a three digit number (320 in the example below) that identifies the parameter version contained in the drive. The display should then read "--", which indicates that the drive is in a STOP condition. This is shown below:

Apply input power

Display flashes parameter version (300-399)

Display then reads "--"

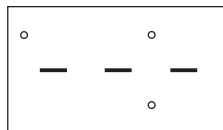
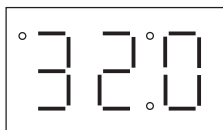

Follow the procedure below to check the motor rotation. This procedure assumes that the drive has been powered up for the first time, and that none of the parameters have been changed.

1. Use the ▼ button to decrease the speed setpoint to 00.0 Hz. The left decimal point will illuminate as the speed setpoint is decreased. If the ▼ button is held down, the speed setpoint will decrease by tenths of Hz until the next whole Hz is reached, and then it will decrease by one Hz increments. Otherwise, each push of the ▼ button will decrease the speed setpoint by a tenth of a Hz.

Once 00.0 Hz is reached, the display will toggle between “00.0” and “- -”, which indicates that the drive is in a STOP condition with a speed setpoint of 00.0 Hz.

2. Give the drive a START command. This can be done using one of several wiring methods described in Section 11.0 - SCL/SCM CONTROL WIRING DIAGRAMS. Once the START command is issued, the display will read “00.0”, indicating that the drive is in a RUN condition with a speed setpoint of 00.0 Hz.
3. Use the ▲ button to increase the speed setpoint until the motor starts to rotate. The left decimal point will light as the speed setpoint is increased. If the ▲ button is held down, the speed setpoint will increase by tenths of Hz until the next whole Hz is reached, and then it will increase by one Hz increments. Otherwise, each push of the button will increase the speed setpoint by a tenth of a Hz.
4. If the motor is rotating in the wrong direction, give the drive a STOP command and remove power from the drive. Wait three minutes for the bus capacitors to discharge, and swap any two of the motor wires connected to U, V, W.

NOTE: The drive is phase insensitive with respect to incoming line voltage. This means that the drive will operate with any phase sequence of the incoming three phase voltage. Therefore, to change the motor rotation, the phases must be swapped at the drive output terminals or at the motor.

13.0 PROGRAMMING THE SCL/SCM DRIVE

The drive may be programmed by one of two methods: using the three buttons and 3-digit LED display on the front of the drive, or programming the Electronic Programming Module (EPM) using the optional EPM Programmer. This section describes programming the drive using the buttons and display, which are shown below:



To enter the PROGRAM mode to access the parameters, press the **Mode** button. This will activate the PASSWORD prompt (if the password has not been disabled). The display will read "00" and the upper right-hand decimal point will be blinking, as shown below:

Press **Mode**

Display reads "00"

Upper right decimal point blinks



Use the **▲** and **▼** buttons to scroll to the password value (the factory default password is "225") and press the **Mode** button. Once the correct password value is entered, the display will read "P01", which indicates that the PROGRAM mode has been accessed at the beginning of the parameter menu (P01 is the first parameter). This is shown below:

Use **▲** and **▼** to scroll to the password value

Press **Mode** to enter password

Parameter menu is accessed at the first parameter

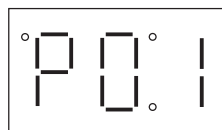
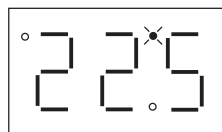

NOTE: If the display flashes “Er”, the password was incorrect, and the process to enter the password must be repeated.

Use the ▲ and ▼ buttons to scroll to the desired parameter number. In the example below, Parameter 19 is being displayed, which is the ACCELERATION TIME of the drive:

Use ▲ and ▼ to scroll to the desired parameter number (the example is Parameter 19 - ACCELERATION TIME)

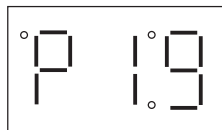

Once the desired parameter number is found, press the **Mode** button to display the present parameter setting. The upper right-hand decimal point will begin blinking, indicating that the present parameter setting is being displayed, and that it can be changed by using the ▲ and ▼ buttons.

Press **Mode** to display present parameter setting (example setting is 20.0)

Upper right decimal point blinks



Use ▲ and ▼ to change setting (example setting changed to 30.0)

Press **Mode** to store new setting



Pressing the **Mode** will store the new setting and also exit the PROGRAM mode. To change another parameter, press the **Mode** key again to re-enter the PROGRAM mode (the parameter menu will be accessed at the parameter that was last viewed or changed before exiting). If the **Mode** key is pressed within two minutes of exiting the PROGRAM mode, the password is not required access the parameters. After two minutes, the password must be entered in order to access the parameters again.

13.1 SETTING VALUES IN TENTHS OF UNITS ABOVE 100

Parameter settings and the keypad speed command can always be adjusted in tenths of unit increments from 0.0 to 99.9. Above 100 however, values can be set in whole units or tenths of units, depending on the setting of Parameter 16 - UNITS EDITING.

If Parameter 16 - UNITS EDITING is set to WHOLE UNITS (02), parameter values and the keypad speed command can only be adjusted by whole unit increments above 100. For example, Parameter 19 - ACCELERATION TIME could not be set to 243.7 seconds. It could only be set to 243 or 244 seconds. Likewise, the keypad speed command (set using the ▲ and ▼ buttons) could not be set to 113.4 Hz. It could only be set to 113 or 114 Hz.

If, however, Parameter 16 - UNITS EDITING is set to TENTHS OF UNITS (01), parameter values and the keypad speed command can be adjusted in tenths of unit increments up to a value of 1000 (above 1000, whole unit increments only). Each push of the ▲ or ▼ button will adjust the value by one tenth of a unit. If the ▲ or ▼ button is pressed and held, the value will increment by tenths of units until the next whole unit is reached, and then the value will increment by whole units.

When a value above 100 is being adjusted by tenths of units, the value is shifted to the left by one digit so that the tenths portion of the value can be displayed. This results in the first digit (reading from left to right) of the value disappearing from the display. Also, the lower decimal point will blink to indicate that the actual value is above 100. Once the value is no longer being adjusted, the value will shift back to the right and the tenths portion of the value will disappear.

In the example below, Parameter 19 - ACCELERATION TIME is presently set to 243.0 seconds, and is being increased to 243.7 seconds.

Go to Parameter 19 and press **Mode**
to see present setting ("243" seconds)



Upper right decimal point blinks

Press ▲ button to see tenths portion

Value shifts to the left ("2" disappears)

Upper right decimal point and lower
decimal point blink



Press ▲ button to scroll up to "43.7"

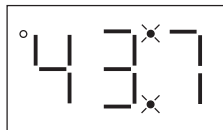

Press **Mode** to store new value

Every SCL/SCM Series drive has an Electronic Programming Module (EPM) installed on the main control board. The EPM stores the user's parameter settings and special OEM default settings (if programmed). The EPM is removable, allowing it to be installed in another drive for quick set-up. For example, if a drive is being replaced with a new one, the EPM can be taken out of the first drive and installed in the new drive. Downtime is minimized because the new drive does not require programming - it is ready to run when the EPM is installed.

The SCL/SCM Series drive contains two or three sets of parameter values, depending on whether the drive has been programmed with optional OEM default settings. The first set of values is the factory default settings, which are permanently stored on the main control board and cannot be changed. The second set of values is the user settings, which are stored in the EPM. When the drive leaves the factory, the user settings are the same as the factory default settings, but the user settings can be changed to configure the drive for a particular application. The optional third set of values is the OEM default settings, which are also stored in the EPM. OEM default settings are typically used in cases where many drives are used for the same application, which requires that all of the drives have the same parameter settings. The OEM default settings cannot be changed without the optional EPM Programmer. The drive can be programmed to operate according to the user settings or the OEM default settings (see Parameter 48 in Section 15.0).

NOTE: The drive will not operate without the EPM installed. The drive will display "F1" if the EPM is missing or damaged.

WARNING!

Do not remove the EPM while power is applied to the drive. Damage to the EPM and/or drive may result.

An EPM Programmer is available as an option from AC Tech, which has the ability to quickly and easily program many SC Series drives for the same configuration. Once a "master" EPM is programmed with the desired parameter settings, the EPM Programmer can copy those settings to other EPMs, allowing many drives to be configured very quickly. Please consult the EPM Programmer Instruction Manual or contact the factory for more information.

If the OEM settings in the EPM become corrupted, the drive will operate normally, until an attempt is made to perform a RESET OEM using Parameter 48 - PROGRAM SELECTION. The drive will then flash "GF" to indicate that the OEM settings are no longer valid. This will require that the EPM be re-programmed using the optional EPM Programmer.

If the OEM settings and the user settings are both corrupted, the drive will display "GF" immediately and the drive will require a RESET 60 or RESET 50 using Parameter 48 - PROGRAM SELECTION. Once the RESET is performed, the parameters can then be programmed individually to match the OEM default settings. This will allow the drive to operate as if it were in OEM mode, even though it is actually operating in USER mode. Refer to Parameter 48 in Section 15.0 - DESCRIPTION OF PARAMETERS.

NOTE: The drive will also display "GF" if a RESET OEM or OPERATE WITH OEM SETTINGS is attempted when the drive is not equipped with the OEM default option.

14.0 PARAMETER MENU

NO.	PARAMETER NAME	RANGE OF ADJUSTMENT	FACTORY DEFAULT
01	LINE VOLTAGE	HIGH (01), LOW (02)	HIGH (01)
02	CARRIER FREQUENCY	4kHz (01), 6 kHz (02), 8 kHz (03), 10 kHz (04)	6 kHz (02)
03	START METHOD	NORMAL (01), START ON POWER UP (02), START WITH DC BRAKE (03), AUTO RESTART WITH DC BRAKE (04), FLYING RESTART 1 (05), FLYING RESTART 2 (06), FLYING RESTART 3 (07)	NORMAL (01)
04	STOP METHOD	COAST (01), COAST WITH DC BRAKE (02), RAMP (03), RAMP WITH DC BRAKE (04)	COAST (01)
05	STANDARD SPEED SOURCE	KEYPAD (01), PRESET #1 (02), 0-10 VDC (03), 4-20 mA (04)	KEYPAD (01)
06	RELAY OUTPUT	NONE (01), RUN (02), FAULT (03), INVERSE FAULT (04), FAULT LOCKOUT (05), AT SET SPEED (06), ABOVE PRESET #3 (07), CURRENT LIMIT (08), AUTO SPEED (09), REVERSE (10)	NONE (01)
10	TB-13A FUNCTION SELECT	NONE (01), 0-10 VDC (02), 4-20 mA (03), PRESET SPEED #1 (04), START FORWARD (05), RUN REVERSE (06), START REVERSE (07), EXTERNAL FAULT (08), INVERSE EXT FAULT (09), AUXILIARY STOP (10), ACCEL/DECCEL #2 (11)	NONE (01)
11	TB-13B FUNCTION SELECT	NONE (01), 0-10 VDC (02), 4-20 mA (03), PRESET SPEED #2 (04), DECREASE FREQ (05), START FORWARD (06), JOG FORWARD (07), JOG REVERSE (08), EXTERNAL FAULT (09), INVERSE EXT FAULT (10), AUX. STOP (11), ACCEL/DECCEL #2 (12), REMOTE KEYPAD (13)	NONE (01)

NO.	PARAMETER NAME	RANGE OF ADJUSTMENT	FACTORY DEFAULT
12	TB-13E INPUT FUNCTIONS	NONE (01), 0-10 VDC (02), 4-20 mA (03), PRESET SPEED #3 (04), INCREASE FREQ (05), START FORWARD (06), EXTERNAL FAULT (07), INVERSE EXT FAULT (08), AUX. STOP (09), ACCEL/DECEL #2 (10),	NONE (01)
	TB-13E OUTPUT FUNCTIONS	RUN (11), FAULT (12), INVERSE FAULT (13), FAULT LOCKOUT (14), AT SET SPEED (15), ABOVE PRESET #3 (16), CURRENT LIMIT (17), AUTO SPEED (18), REVERSE (19), DYNAMIC BRAKING (20),	
	OTHER FUNCTIONS	REMOTE KEYPAD (21)	
14	CONTROL	TERMINAL STRIP ONLY (01) REMOTE KEYPAD ONLY (02)	TERMINAL STRIP ONLY (01)
16	UNITS EDITING	TENTHS OF UNITS (01), WHOLE UNITS (02)	WHOLE UNITS (02)
17	ROTATION	FORWARD ONLY (01), FORWARD AND REVERSE (02)	FORWARD ONLY (01)
19	ACCELERATION TIME	0.1 - 3600.0 SEC	20.0 SEC
20	DECELERATION TIME	0.1 - 3600.0 SEC	20.0 SEC
21	DC BRAKE TIME	0.0 - 3600.0 SEC	0.0 SEC
22	DC BRAKE VOLTAGE	0.0 - 30.0 %	0.0 %
23	MINIMUM FREQUENCY	0.0 - MAXIMUM FREQUENCY	0.0 Hz
24	MAXIMUM FREQUENCY	MINIMUM FREQUENCY - 240 Hz	SCL = 50.0 Hz SCM = 60.0 Hz
25	CURRENT LIMIT	30 - 180 %	180 %
26	MOTOR OVERLOAD	30 - 100 %	100 %
27	BASE FREQUENCY	25.0 - 500.0 Hz	SCL = 50.0 Hz SCM = 60.0 Hz
28	FIXED BOOST	0.0 - 30.0 %	1.0 %
29	ACCEL BOOST	0.0 - 20.0 %	0.0 %

NO.	PARAMETER NAME	RANGE OF ADJUSTMENT	FACTORY DEFAULT
30	SLIP COMPENSATION	0.0 - 5.0 %	0.00%
31-37	PRESET SPEEDS	0.0 - MAXIMUM FREQUENCY	0.0 Hz
38	SKIP BANDWIDTH	0.0 - 10.0 Hz	0.0 Hz
39	SPEED SCALING	0.0 - 6500.0	0.0
42	ACCEL / DECEL #2	0.1 - 3600.0 SEC	20.0 SEC
44	PASSWORD	000 - 999	225
45	SPD AT MIN SIGNAL	MINIMUM FREQUENCY - 999 Hz	0.0 Hz
46	SPD AT MAX SIGNAL	MINIMUM FREQUENCY - 999 Hz	SCL = 50.0 Hz SCM = 60.0 Hz
47	CLEAR HISTORY	MAINTAIN (01), CLEAR (02)	MAINTAIN (01)
48	PROGRAM SELECTION	USER SETTINGS (01), OEM SETTINGS (02), RESET OEM (03), RESET 60 (04), RESET 50 (05), TRANSLATE (06)	SCL = RESET 50 (05) SCM = RESET 60 (04)
50	FAULT HISTORY	(VIEW-ONLY)	(N/A)
51	SOFTWARE CODE	(VIEW-ONLY)	(N/A)
52	DC BUS VOLTAGE	(VIEW-ONLY)	(N/A)
53	MOTOR VOLTAGE	(VIEW-ONLY)	(N/A)
54	LOAD	(VIEW-ONLY)	(N/A)
55	0-10 VDC INPUT	(VIEW-ONLY)	(N/A)
56	4-20 mA INPUT	(VIEW-ONLY)	(N/A)
57	TB STRIP STATUS	(VIEW-ONLY)	(N/A)
58	KEYPAD STATUS	(VIEW-ONLY)	(N/A)

15.0 DESCRIPTION OF PARAMETERS

P01 LINE VOLTAGE SELECTION

This calibrates the drive for the actual applied input voltage. Set this parameter to HIGH (01) for 120, 220-240, and 460-480 Vac input, or LOW (02) for 200-208 and 380-415 Vac input.

NOTE: If this parameter is changed while the drive is running, the new value will not take effect until the drive is stopped.

P02 CARRIER FREQUENCY

This sets the switching rate of the output IGBT's. Increasing the carrier frequency will result in less audible motor noise. Available settings are: 4 kHz, 6 kHz, 8 kHz, and 10 kHz.

PARAMETER SETTING	CARRIER FREQUENCY	AMBIENT OR OUTPUT DERATE (NOTE 2)
01	4 kHz	40 C or 100%
02	6 kHz	40 C or 100%
03	8 kHz	40 C or 100%
04	10 kHz	35 C or 92%

NOTE 1: The SCL/SCM drive is fully rated up to 8 kHz carrier frequency. If the 10 kHz carrier frequency is selected, the drive's ambient temperature rating OR output current rating must be derated to the value shown in the table above.

NOTE 2: If this parameter is changed while the drive is running, the change will not take effect until the drive is stopped.

P03 START METHOD

WARNING!

Automatic starting of equipment may cause damage to equipment and/or injury to personnel! Automatic start should only be used on equipment that is inaccessible to personnel.

- 01 **NORMAL:** The drive will start when the appropriate contact is closed on the terminal strip. See Section 11 for possible control configurations.
- 02 **START ON POWER UP:** The drive will automatically start upon application of input power.
- 03 **START WITH DC BRAKE:** When a START command is given, the drive will apply DC BRAKE VOLTAGE (Parameter 22) for the duration of DC BRAKE TIME (Parameter 21) prior to starting the motor to ensure that the motor is not turning.

- 04 AUTO RESTART WITH DC BRAKING: Upon a START command, after a fault, or upon application of power, the drive will apply DC BRAKE VOLTAGE (Parameter 22) for the duration of DC BRAKE TIME (Parameter 21) prior to starting (or restarting) the motor.
- 05 FLYING RESTART 1: LOW performance. Slowest synchronization and lowest current level. This setting results in the smoothest synchronization.
- 06 FLYING RESTART 2: MEDIUM performance. Faster synchronization and higher current level. This setting allows faster synchronization while retaining smoothness.
- 07 FLYING RESTART 3: HIGH performance. Fastest synchronization and highest current level. This setting allows the fastest synchronization, but sacrifices smoothness.

When programmed for auto-restart (settings 04 - 07), the drive will attempt three restarts after a fault. The interval between restart attempts is 15 seconds for setting 04, and 2 seconds for settings 05, 06 and 07. During the interval between restart attempts, the display will read “SP” to indicate Start Pending. If all three restart attempts fail, the drive will trip into FAULT LOCKOUT (displayed “LC”) and require a manual reset. Refer to Section 16.0 - TROUBLESHOOTING.

The FLYING RESTART 1 - 3 settings allow the drive to start into a spinning load after a fault or upon application of input power. They differ in the time required to find the motor speed and the amount of current required to synchronize with it. The faster the drive attempts to find the motor speed, the more current is required. The first two restart attempts will try to start into the spinning load, but the third restart attempt will act like AUTO RESTART WITH DC BRAKING.

NOTE: Settings 02 and 04 - 07 require a two-wire start/stop circuit to operate. The RUN contact must remain closed for the power-up start and auto-restart functions to operate.

P04 STOP METHOD

- 01 COAST TO STOP: When a STOP command is given, the drive shuts off the output to the motor, allowing it to coast freely to a stop.
- 02 COAST WITH DC BRAKE: When a stop command is given, the drive will activate DC braking (after a delay of up to 2 seconds, depending on frequency) to help decelerate the load. Refer to Parameters: 21 - DC BRAKE TIME, and 22 - DC BRAKE VOLTAGE.
- 03 RAMP TO STOP: When a stop command is given, the drive will decelerate the motor to a stop at the rate determined by Parameter 20 - DECELERATION TIME.
- 04 RAMP WITH DC BRAKE: When a stop command is given, the drive will decelerate the motor down to 0.2 Hz (at the rate set by Parameter 20 - DECELERATION TIME) and then activate DC braking according to the settings of Parameters 21 - DC BRAKE TIME and 22 - DC BRAKE VOLTAGE. This is used to bring the load to a final stop, as the motor may still be turning slightly after the drive stops.

P05 STANDARD SPEED SOURCE

This selects the speed reference source when the drive is in STANDARD speed mode. The following speed references can be selected:

- 01 KEYPAD: Use the ▲ and ▼ buttons to scroll to the desired speed.
- 02 PRESET SPEED #1: The drive will operate at the frequency set into Parameter 31.
- 03 0-10 VDC: The drive will respond to a 0-10 VDC signal wired to TB-5 (+) and TB-2 (-).
- 04 4-20 mA: The drive will respond to a 4-20 mA signal wired to TB-25 (+) and TB-2 (-).

P06 RELAY OUTPUT

This selects the status indication for the normally open relay output at TB-16 and TB-17:

- 01 NONE: Disables the relay output.
- 02 RUN: Closes upon a START command. Opens if the drive is in a STOP state, the drive faults, or input power is removed. DC braking is considered a STOP state.
- 03 FAULT: Closes if there is no fault condition. Opens if the drive faults, or input power is removed.
- 04 INVERSE FAULT: Closes if the drive faults. Opens if there is no fault condition.
- 05 FAULT LOCKOUT: Closes when input power is applied. Opens if three restart attempts are unsuccessful, or if input power is removed.
- 06 AT SET SPEED: Closes if the drive is within ± 0.5 Hz of the speed setpoint.
- 07 ABOVE PRESET SPEED #3: Closes if the output frequency exceeds PRESET SPEED #3 (Parameter 33). Opens if the output frequency is equal to or less than PRESET SPEED #3.
- 08 CURRENT LIMIT: Closes if the output current exceeds the CURRENT LIMIT setting. Opens if the output current is equal to or less than CURRENT LIMIT (see Parameter 25).
- 09 AUTOMATIC SPEED MODE: Closes if an AUTOMATIC (terminal strip) speed reference is active. Opens if a STANDARD (Parameter 5) speed reference is active.
- 10 REVERSE: Closes when reverse rotation is active. Opens when forward rotation is active (see Parameter 17 - ROTATION DIRECTION).

P10 TB-13A FUNCTION SELECT

This selects the function of terminal TB-13A. Closing TB-13A to TB-11 (or opening in the case of settings 08 and 10) activates the selected function. The following functions can be selected:

- 01 NONE: Disables the TB-13A function.
- 02 0-10 VDC: Selects a 0-10 VDC signal (at TB-5) as the AUTO speed reference input.
- 03 4-20 mA: Selects a 4-20 mA signal (at TB-25) as the AUTO speed reference input.
- 04 PRESET SPEED #1: Selects PRESET SPEED #1 as the speed reference. The drive will operate at the frequency programmed into Parameter 31.
- 05 START FORWARD: Sets up the drive for a 3-wire start/stop circuit. Momentarily close TB-13A to TB-11 to start the drive, and momentarily open TB-1 to TB-11 to stop.
- 06 RUN REVERSE: Close TB-13A to TB-11 to run in the reverse direction, and open to stop. Close TB-1 to TB-11 to run in the forward direction and open to stop.
- 07 START REVERSE: Momentarily close TB-13A to TB-11 to start the drive in the reverse direction, and momentarily open TB-1 to TB-11 to stop. Parameter 17 - ROTATION must be set to FORWARD AND REVERSE (02), and TB-13E must be used for START FORWARD.
- 08 EXTERNAL FAULT: Sets TB-13A as a normally closed external fault input. Open TB-13A to TB-11 to trip the drive.
- 09 INVERSE EXTERNAL FAULT: Sets TB-13A as a normally open external fault input. Close TB-13A to TB-11 to trip the drive.
- 10 AUXILIARY STOP: When TB-13A is opened with respect to TB-11, the drive will decelerate to a STOP (even if STOP METHOD is set to COAST) at the rate set into ACCEL/DECCEL #2 (Parameter 42).
- 11 ACCEL/DECCEL #2: Selects the acceleration and deceleration time programmed into ACCEL/DECCEL #2 (Parameter 42).

P11 TB-13B FUNCTION SELECT

This selects the function of terminal TB-13B. Closing TB-13B to TB-11 (or opening in the case of settings 09 and 11) activates the selected function. The following functions can be selected:

- 01 NONE: Disables the TB-13B function.
- 02 0-10 VDC: Selects a 0-10 VDC signal (at TB-5) as the AUTO speed reference input.
- 03 4-20 mA: Selects a 4-20 mA signal (at TB-25) as the AUTO speed reference input.

- 04 PRESET SPEED #2: Selects PRESET SPEED #2 as the speed reference. The drive will operate at the frequency programmed into Parameter 32.
- 05 DECREASE FREQ: Closing TB-13B to TB-11 will decrease the speed setpoint until the contact is opened. TB-13E must be programmed for INCREASE FREQ.
- 06 START FORWARD: Sets up the drive for a 3-wire start/stop circuit. Momentarily close TB-13B to TB-11 to start the drive, and momentarily open TB-1 to TB-11 to stop.
- 07 JOG FORWARD: Close TB-13B to TB-11 to JOG in the forward direction. The drive will run at PRESET SPEED #2 (Parameter 32) when in JOG mode.
- 08 JOG REVERSE: Close TB-13B to TB-11 to JOG in the reverse direction. The drive will run at PRESET SPEED #2 (Parameter 32) when in JOG mode.

WARNING!

When operating in JOG mode, the STOP signal and the AUXILIARY STOP function (see Parameters 10-12) **WILL NOT** stop the drive. To stop the drive, remove the JOG command.

JOG REVERSE will operate the drive in reverse rotation even if ROTATION DIRECTION (Parameter 17) is set to FORWARD ONLY.

- 09 EXTERNAL FAULT: Sets TB-13B as a normally closed external fault input. Open TB-13B to TB-11 to trip the drive.
- 10 INVERSE EXTERNAL FAULT: Sets TB-13B as a normally open external fault input. Close TB-13B to TB-11 to trip the drive.
- 11 AUXILIARY STOP: When TB-13B is opened with respect to TB-11, the drive will decelerate to a STOP (even if STOP METHOD is set to COAST) at the rate set into ACCEL/DECCEL #2 (Parameter 42).
- 12 ACCEL/DECCEL #2: Selects the acceleration and deceleration time programmed into Parameter 42 - ACCEL/DECCEL #2.
- 13 REMOTE KEYPAD: When the Remote Keypad option is being used, TB-13B must be set to this function. Also, TB-13E (Parameter 12) must be set for REMOTE KEYPAD (21), and CONTROL (Parameter 14) must be set to REMOTE KEYPAD ONLY (02).

NOTE 1: If the drive is commanded to JOG while running, the drive will enter JOG mode and run at PRESET SPEED #2 (Parameter 32). When the JOG command is removed, the drive will STOP.

P12 TB-13E FUNCTION SELECT

This selects the function of terminal TB-13E. This terminal can be configured as a digital input (settings 01 to 10) or a digital status output (settings 11 to 20). When used as an input, closing TB-13E to TB-11 (or opening in the case of settings 07 and 09) activates the selected function.

When used as an output, it can provide the drive's status for monitoring. If the Remote Keypad option is being used, this parameter must be set to REMOTE KEYPAD (21).

The following input functions can be selected:

- 01 NONE: Disables the TB-13E function.
- 02 0-10 VDC: Selects a 0-10 VDC signal (at TB-5) as the AUTO speed reference input.
- 03 4-20 mA: Selects a 4-20 mA signal (at TB-25) as the AUTO speed reference input.
- 04 PRESET SPEED #3: Selects PRESET SPEED #3 as the speed reference. The drive will operate at the frequency programmed into Parameter 33.
- 05 INCREASE FREQ: Closing TB-13E to TB-11 will increase the speed setpoint until the contact is opened. INCREASE FREQ will only work when the drive is running. TB-13B must be programmed for DECREASE FREQ.
- 06 START FORWARD: Sets up the drive for a 3-wire start/stop circuit. Momentarily close TB-13E to TB-11 to start the drive, and momentarily open TB-1 to TB-11 to stop.
- 07 EXTERNAL FAULT: Sets TB-13E as a normally closed external fault input. Open TB-13E to TB-11 to trip the drive.
- 08 INVERSE EXTERNAL FAULT: Sets TB-13E as a normally open external fault input. Close TB-13E to TB-11 to trip the drive.
- 09 AUXILIARY STOP: When TB-13E is opened with respect to TB-11, the drive will decelerate to a STOP (even if STOP METHOD is set to COAST) at the rate set into ACCEL/DECEL #2 (Parameter 42).
- 10 ACCEL/DECEL #2: Selects the acceleration and deceleration time programmed into ACCEL/DECEL #2 (Parameter 42).

The following output functions can be selected. The terms "open" and "close" refer to the state of the internal transistor that activates the circuit. When the transistor is "closed" the circuit is complete, and TB-13E is pulled up to 15 VDC (when "open", TB-13E is at 0 VDC potential).

- 11 RUN: Closes upon a START command. Opens if the drive is in a STOP state, the drive faults, or input power is removed. DC braking is considered a STOP state.
- 12 FAULT: Closes if there is no fault condition. Opens if the drive faults, or input power is removed.
- 13 INVERSE FAULT: Closes if the drive faults. Opens if there is no fault condition.
- 14 FAULT LOCKOUT: Closes when input power is applied. Opens if three restart attempts are unsuccessful, or if input power is removed.

- 15 AT SET SPEED: Closes if the drive is within ± 0.5 Hz of the speed setpoint.
- 16 ABOVE PRESET SPEED #3: Closes if the output frequency exceeds PRESET SPEED #3 (Parameter 33). Opens if the output frequency is equal to or less than PRESET SPEED #3.
- 17 CURRENT LIMIT: Closes if the output current exceeds the CURRENT LIMIT setting. Opens if the output current is equal to or less than CURRENT LIMIT (see Parameter 25).
- 18 AUTOMATIC SPEED MODE: Closes if an AUTOMATIC (terminal strip) speed reference is active. Opens if a STANDARD (Parameter 5) speed reference is active.
- 19 REVERSE: Closes when reverse rotation is active. Opens when forward rotation is active (see Parameter 17 - ROTATION DIRECTION).
- 20 DYNAMIC BRAKING: TB-13E becomes the "trigger" that activates the optional external Dynamic Braking module. Refer to the instructions included with the Dynamic Braking option.
- 21 REMOTE KEYPAD: When the Remote Keypad option is being used, TB-13E must be set for this function. Also, TB-13B (Parameter 11) must be set for Remote Keypad (13) and CONTROL (Parameter 14) must be set for REMOTE KEYPAD ONLY (02).

P14 CONTROL

Selects the source of START/STOP and direction commands.

- 01 TERMINAL STRIP ONLY: The drive will only respond to START/STOP and direction commands from the terminal strip.
- 02 REMOTE KEYPAD ONLY: The drive will only respond to START/STOP and direction commands from the optional remote keypad. Terminals 13B and 13E must also be set for the REMOTE KEYPAD option (refer to Parameters 12 and 13).

P16 UNITS EDITING

This allows parameter and keypad speed editing in whole units or tenths of units above 100. Below 100, the value can always be changed by tenths of units.

- 01 TENTHS OF UNITS: The value can always be changed by tenths of units (up to a value of 1000). If the ▲ or ▼ button is pressed and held, the value will change by tenths of units until the next whole unit is reached, and then the value will change by whole units. Refer to Section 13.1.
- 02 WHOLE UNITS: The value can be changed by tenths of units until 99.9 is reached. Above 99.9, the value will change in whole unit increments only. Below a value of 100, if the ▲ or ▼ button is pressed and held, the value will change by tenths of units until the next whole unit is reached,

and then the value will change by whole units.

P17 ROTATION DIRECTION

- 01 FORWARD ONLY: The drive will only allow rotation in the forward direction. However, JOG REVERSE (see Parameter 11) will still operate even if FORWARD ONLY is selected.
- 02 FORWARD AND REVERSE: The drive will allow rotation in both directions.

P19 ACCELERATION TIME

This sets the acceleration rate for all of the speed reference sources (keypad, speed pot, jog, MOP, and preset speeds). This setting is the time to accelerate from 0 Hz to the BASE FREQUENCY (Parameter 27).

P20 DECELERATION TIME

This sets the deceleration rate for all of the speed reference sources (keypad, speed pot, jog, MOP, and preset speeds). This setting is the time to decelerate from BASE FREQUENCY to 0 Hz. If the drive is set for COAST TO STOP (setting 01 or 02 in Parameter 04), this parameter will have no effect when a STOP command is given.

P21 DC BRAKE TIME

This sets the length of time that the DC braking voltage is applied to the motor. The DC BRAKE TIME should be set to the lowest value that provides satisfactory operation in order to minimize motor heating.

P22 DC BRAKE VOLTAGE

This sets the magnitude of the DC braking voltage, in percentage of the line voltage. The point at which the DC braking is activated depends on the selected STOP METHOD (Parameter 04):

If COAST WITH DC BRAKE is selected, braking is activated after a time delay of up to 2 seconds, depending on the output frequency at the time of the STOP command. In this case, the DC braking is the only force acting to decelerate the load.

If RAMP WITH DC BRAKE is selected, braking is activated when the output frequency reaches 0.2 Hz. In this case, the drive decelerates the load to a near stop and then DC braking is used to bring the load to a final stop.

P23 MINIMUM FREQUENCY

This sets the minimum output frequency of the drive for all speed reference sources except the PRESET SPEEDS (Parameters 31-37), and is used with MAXIMUM FREQUENCY (Parameter 24) to define the operating range of the drive.

When using an analog input speed reference (0-10 VDC or 4-20 mA), Parameters 45 and 46 (SPEED AT MIN SIGNAL and SPEED AT MAX SIGNAL) also affect the drive's speed range.

NOTE: If this parameter is changed while the drive is running, the new value will not take effect until the drive is stopped.

P24 MAXIMUM FREQUENCY

This sets the maximum output frequency of the drive for all speed reference sources, and is used with MINIMUM FREQUENCY (Parameter 23) to define the operating range of the drive.

When using an analog input speed reference (0-10 VDC or 4-20 mA), Parameters 45 and 46 (SPEED AT MIN SIGNAL and SPEED AT MAX SIGNAL) also affect the drive's speed range.

NOTE: If this parameter is changed while the drive is running, the new value will not take effect until the drive is stopped.

P25 CURRENT LIMIT

This sets the maximum allowable output current of the drive. The maximum setting is either 180% or 150%, depending on whether LINE VOLTAGE SELECTION (Parameter 01) is set to HIGH or LOW.

If the load demands more current than the CURRENT LIMIT setting, the drive will reduce the output frequency in an attempt to reduce the output current. When the overcurrent condition passes, the drive will accelerate the motor back up to the speed setpoint.

P26 MOTOR OVERLOAD

The SCL/SCM Series is UL approved for solid state motor overload protection, and therefore does not require a separate thermal overload relay for single motor applications. This circuit allows the drive to deliver up to 150% current for one minute. If the overload circuit “times out”, the drive will trip into an OVERLOAD fault (displayed as “PF”). MOTOR OVERLOAD should be set to the ratio (in percent) of the motor current rating to the drive's output current rating to properly protect the motor.

Example: A 3 HP, 480 Vac drive with a 4.8 Amp rating is operating a 2 HP motor with a current rating of 3.4 Amps. Dividing the motor current rating by the drive's output current rating yields 71% ($3.4 / 4.8 = 0.71 = 71\%$), so this parameter should be set to 71%.

P27 BASE FREQUENCY

The BASE FREQUENCY determines the V/Hz ratio by setting the output frequency at which the drive will output full voltage to the motor. In most cases, the BASE FREQUENCY should be set to match the motor's rated frequency.

Example: A 230 Vac, 60 Hz motor requires a V/Hz ratio of 3.83 ($230 \text{ V} / 60 \text{ Hz} = 3.83 \text{ V/Hz}$) to produce full torque. Setting the BASE FREQUENCY to 60 Hz causes the drive to output full voltage (230 Vac) at 60 Hz, which yields the required 3.83 V/Hz. Output voltage is proportional to output frequency, so the 3.83 V/Hz ratio is maintained from 0 - 60 Hz, allowing the motor to produce full torque from about 2 Hz (below 2 Hz there is less torque due to slip) up to 60 Hz.

NOTE: If this parameter is changed while the drive is running, the new value will not take effect until the drive is stopped.

P28 FIXED BOOST

FIXED BOOST increases starting torque by increasing the output voltage when operating below half of the base frequency. For better out-of-the-box performance, SCL/SCM Series drives are shipped with a setting that is different from the factory default of 1%. Units rated 0.33 to 1 HP (0.25 to 0.75 kW) = 5.3%, 1.5 to 2 HP (1.1 to 1.5 kW) = 4.4%, 3 HP (2.2 kW) = 3.6%, 5 HP (4 kW) = 3.0%, 7.5 HP (5.5 kW) = 2.7%, 10 HP (7.5 kW) = 2.4%, and 15 HP (11 kW) = 2.2%.

P29 ACCELERATION BOOST

ACCELERATION BOOST helps accelerate high-inertia loads. During acceleration, the output voltage is increased to increase motor torque. Once the motor reaches the new speed setpoint, the boost is turned off and the output voltage returns to the normal value.

P30 SLIP COMPENSATION

SLIP COMPENSATION is used to counteract changes in motor speed (slip) caused by changes in load. In a standard AC induction motor, the shaft speed decreases as load increases, and increases as load decreases. By increasing or decreasing the output frequency in response to an increasing or decreasing load, the slip is counteracted and speed is maintained. Most standard NEMA B motors have a 3% slip rating.

P31 - P37 PRESET SPEED #1 - #7

Preset speeds are activated by contact closures between TB-11 and TB-13A, 13B, and 13E. The TB-13 terminals must be programmed as preset speed selects using Parameters 10-12.

NOTE 1: Preset speeds can operate below the frequency defined by the Minimum Frequency parameter (Parameter 23).

Refer to the table below for activation of the preset speeds using the TB-13 terminals:

SPEED #	TB - 13A	TB - 13B	TB - 13E
1	CLOSED	OPEN	OPEN
2	OPEN	CLOSED	OPEN
3	OPEN	OPEN	CLOSED
4	CLOSED	CLOSED	OPEN
5	CLOSED	OPEN	CLOSED
6	OPEN	CLOSED	CLOSED
7	CLOSED	CLOSED	CLOSED

NOTE 2: When a TB-13 terminal is programmed for a function other than a preset speed select, it is considered OPEN for the table above.

Preset Speed #6 and #7 can also be used as skip frequencies to restrict the drive from operating at frequencies that cause vibration in the system. See Parameter 38 below.

P38 SKIP BANDWIDTH

The SCL/SCM drive has two skip frequencies that can be used to lock out critical frequencies that cause mechanical resonance in the system. Once SKIP BANDWIDTH is set to a value other than 0 Hz, the skip frequencies are enabled. When the skip frequency function is enabled, PRESET SPEED #6 and #7 are used as the skip frequencies. SKIP BANDWIDTH sets the range above the skip frequencies that the drive will not operate within.

Example: The critical frequency is 23 Hz, and it is desired to skip a frequency range of 3 Hz above and below the critical frequency (therefore the skip range is 20 to 26 Hz). PRESET SPEED #6 or #7 would be set to 20 Hz, and the SKIP BANDWIDTH would be set to 6 Hz.

If the drive is running at a speed below the skip range, and it is given a speed command that is within the skip range, the drive will accelerate to the start of the skip range (20 Hz in the example) and run at that speed until the speed command is greater than or equal to the "top" of the skip range. The drive will then accelerate through the skip range to the new speed. Likewise, if the drive is running at a speed above the skip range, and it is given a speed command that is within the skip range, the drive will decelerate to the "top" of the skip range (26 Hz in the example) and run at that speed until the speed command is less than or equal to the "bottom" of the skip range. The drive will then decelerate through the skip range to the new speed.

NOTE: PRESET SPEEDS #6 and #7 can still be used as preset speeds even if they are also being used as skip frequencies.

P39 SPEED SCALING

This scales the display to indicate speed in units other than frequency. This parameter should be set to the desired display value when the drive output is 60 Hz. The highest setting is 6500, and the highest value that can be displayed is 6553.6. If SPEED SCALING is set to 0.0, the speed scaling function is disabled and the display will indicate frequency.

Example: A machine produces 175 parts per hour when the motor is running at 60 Hz. Setting SPEED SCALING to 175 will calibrate the drive's display to read 175 when the motor is running at 60 Hz. This is a linear function, so at 30 Hz the display would read 87.5 Hz, and at 120 Hz the display would read 350.

NOTE 1: If the displayed value will exceed 999, the value is shown in two parts. For example, if the displayed value is 1800, the display will indicate this by toggling between "1--" and "800".

NOTE 2: If SPEED SCALING is set such that the maximum displayable value (6553.6) is exceeded, the display will flash "9999" to indicate that the value is out of range. For example, if SPEED SCALING is set to 6000, the drive will display 6000 when it is running at 60 Hz. If the speed is increased past 65.5 Hz (at 65.5 Hz, the scaled value would be 6550), the display will flash "9999" because a scaled value above 6553.6 cannot be displayed.

P42 ACCEL / DECEL #2

This parameter sets the second acceleration and deceleration rate of the drive, which can be activated using terminals TB-13A, 13B, or 13E (Parameter 10, 11, or 12).

P44 PASSWORD

This allows the PASSWORD to be changed to any number between 000 and 999. Setting PASSWORD to 000 disables the password function.

NOTE: The factory default password is 225.

P45 SPEED AT MIN SIGNAL

This sets the speed at which the drive will run when it receives the minimum speed reference signal (0 VDC or 4 mA). This is used in conjunction with SPEED AT MAX SIGNAL (Parameter 46) to define the speed range of the drive when following an analog speed reference signal.

P46 SPEED AT MAX SIGNAL

This sets the speed at which the drive will run when it receives the maximum speed reference signal (10 VDC or 20 mA). This is used in conjunction with SPEED AT MIN SIGNAL (Parameter 45) to define the speed range of the drive when following an analog speed reference signal.

NOTE: If SPEED AT MIN SIGNAL is set higher than SPEED AT MAX SIGNAL, the drive will react inversely to the speed reference signal. Therefore, as the speed reference signal increases, the drive speed will decrease, and vice-versa.

P47 CLEAR FAULT HISTORY

01 MAINTAIN: Maintains the FAULT HISTORY (Parameter 50) entries for troubleshooting.

02 CLEAR: Erases the FAULT HISTORY (Parameter 50) entries.

P48 PROGRAM SELECTION

This is used to select whether the drive will operate according to the user settings or the optional OEM default settings, and to reset the parameters to default settings. Refer to Section 13.2.

01 OPERATE WITH USER SETTINGS: The drive will operate according to the user settings. Operation in USER mode allows the parameter values to be changed to suit any application.

02 OPERATE WITH OEM DEFAULTS: The drive will operate according to the optional OEM default settings, which configure the drive for a specific application. When operating in OEM mode, the parameter values can be viewed, but not changed. If an attempt is made to change a parameter setting, the display will flash “GE”. If the drive is not programmed with OEM default settings, the display will flash “GF” if this option is selected.

03 RESET OEM: Resets the user parameters to the OEM default settings. If the drive is not programmed with OEM default settings, the display will flash “GF” if this option is selected.

- 04 RESET 60: Resets the user parameters to the factory defaults for a 60 Hz base frequency. Parameters 24, 27, and 46 will reset to 60.0 Hz.
- 05 RESET 50: Resets the user parameters to the factory defaults for a 50 Hz base frequency. Parameters 24, 27, and 46 will reset to 50.0 Hz.
- 06 TRANSLATE: If an EPM from a drive with a previous (but compatible) parameter version is installed in a new drive, the new drive will function like the previous version drive, but none of the parameter settings can be changed ("cE" will be displayed if this is attempted). The TRANSLATE function converts the EPM to the new parameter version so that the parameters can be changed, but it also retains the old parameter settings so the new drive will operate like the old drive without having to re-program all of the parameters. Once the EPM is "translated", it will no longer work in the old drive.

NOTE 1: If the user parameters are reset to the OEM defaults (using the RESET OEM option), and then OPERATE WITH USER SETTINGS is selected, the USER settings will be the same as the OEM default settings. This allows the drive to operate as if it was in OEM mode, but the parameter values can be changed. This is useful if some of the OEM default settings need to be fine-tuned for proper operation. The new parameter values are not actually stored as new OEM default settings however; they are simply stored as new USER settings. Therefore, if the parameters are reset to the OEM defaults again, the parameters that were changed will be reset to their "old" value. The optional EPM Programmer is required to change OEM default settings. Refer to Section 13.2.

NOTE 2: Only the TRANSLATE (06) function can be performed while the drive is running. The display will flash "Er" if an attempt is made to select any other function while the drive is running.

P50 FAULT HISTORY

The FAULT HISTORY stores the last eight faults that tripped the drive. Refer to Section 16.0 - TROUBLESHOOTING for a list of the faults and possible causes.

Use the ▲ and ▼ buttons to scroll through the fault entries. The faults are stored from newest to oldest, with the first fault shown being the most recent.

The display will read " _ _ " if the FAULT HISTORY does not contain any fault messages.

P51 SOFTWARE VERSION

This displays the software version number for the control board software. This information is useful when contacting the factory for programming or troubleshooting assistance.

The software version is displayed in two parts which alternate. The first part is the software version, and the second part is the revision number. For example, if the display flashes "94" and "02", this indicates that the drive contains the second revision of version 94 software.

P52 DC BUS VOLTAGE

This displays the DC bus voltage in percent of nominal. Nominal DC bus voltage is determined by multiplying the drive's nameplate input voltage rating by 1.4.

P53 MOTOR VOLTAGE

This displays the output voltage in percent of the drive's nameplate output voltage rating.

P54 MOTOR LOAD

This displays the motor load in percent of the drive's output current rating.

P55 0-10 VDC INPUT

This displays the level of the 0-10 VDC input signal at TB-5. A reading of 100% indicates a 10 VDC input at TB-5.

P56 4-20 mA INPUT

This displays the level of the 4-20 mA input signal at TB-25. A reading of 20% indicates a 4 mA input at TB-25, and a reading of 100% indicates a 20 mA input at TB-25.

P57 TERMINAL STRIP STATUS

This indicates the status of several terminals using the vertical segments of the LED display. An illuminated segment indicates that the particular terminal is closed to TB-11. See the diagram below:

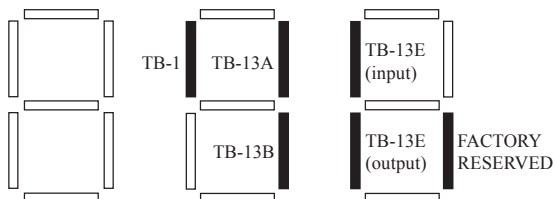

P58 KEYPAD AND PROTECTION STATUS

This indicates the status of the buttons on the keypad, and the status of the protective circuitry in the drive, using the horizontal segments of the LED. An illuminated segment indicates that the corresponding button is pressed, or the protective circuit is active. See the diagram below:

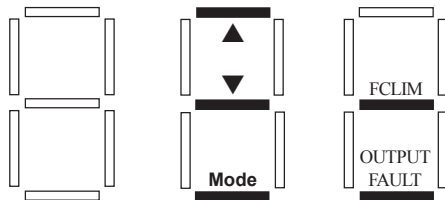

NOTE: FCLIM is an abbreviation for Fast Current Limit.

16.0 TROUBLESHOOTING

To aid in troubleshooting, Parameters 50 through 60 can be accessed without entering the PASSWORD. Simply press the **Mode** button twice to “skip” over the PASSWORD prompt, and “P50” will be displayed to indicate that the parameter menu has been entered and Parameter 50 (FAULT HISTORY) can be viewed. The **▲** and **▼** buttons can then be used to scroll from Parameter 50 to Parameter 60. Once the desired parameter is found, press the **Mode** button to view its “contents”. When finished, press **Mode** to exit the parameter menu. An example is shown below:

Press **Mode** once

Display reads "00"

Upper right decimal point blinks



Press **Mode** again

Display reads "P50" (FAULT HISTORY)



Use **▲** and **▼** to scroll to the desired parameter number

(In this example Parameter 54 has been selected, which is MOTOR LOAD)

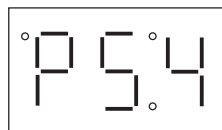

Press **Mode** to view parameter contents
(77 = 77% LOAD)

Upper right decimal point blinks

Press **Mode** again to exit

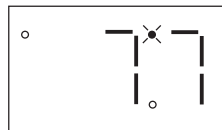

In the example above, Parameter 54 - MOTOR LOAD is being viewed. The “77” in the example indicates that the load on the motor is 77% of the output current rating of the drive.

The table below lists the fault conditions that will cause the drive to shut down, as well as some possible causes. Please contact the factory for more information on troubleshooting faults.

FAULT MESSAGES	
FAULT	DESCRIPTION & POSSIBLE CAUSES
AF	High Temp. Fault: Ambient temperature is too high; Cooling fan has failed (if equipped).
CF	Control Fault: A blank EPM, or an EPM with corrupted data has been installed. Perform a factory reset using Parameter 48 - PROGRAM SELECTION.
cF	Incompatibility Fault: An EPM with an incompatible parameter version has been installed. Either remove the EPM or perform a factory reset (Parameter 48) to change the parameter version of the EPM to match the parameter version of the drive.
dF	Dynamic Braking Fault: The drive has sensed that the dynamic braking resistors are overheating and shuts down to protect the resistors.
EF	External Fault: One of the TB-13 terminals is set as an External Fault input and that terminal is open with respect to TB-11. Refer to Parameters 10, 11 and 12.
GF	Data Fault: User data and OEM defaults in the EPM are corrupted.
HF	High DC Bus Voltage Fault: Line voltage is too high; Deceleration rate is too fast; Overhauling load. For fast deceleration or overhauling loads, dynamic braking may be required.
JF	Remote Keypad Fault: The communication link between the drive and the optional Remote Keypad has been lost. Check for proper wiring and/or noise.
LF	Low DC Bus Voltage Fault: Line voltage is too low.
OF	Output Transistor Fault: Phase to phase or phase to ground short circuit on the output; Boost settings are too high; Acceleration rate is too fast; Failed output transistor.
PF	Current Overload Fault: VFD is undersized for the application; Mechanical problem with the driven equipment.
UF	Start Fault: Start command was present when the drive was powered up. Must wait 2 seconds after power-up to apply Start command if START METHOD is set to NORMAL.
F1	EPM Fault: The EPM is missing or damaged.
FC, F2 - F9, Fo	Internal Faults: The control board has sensed a problem - consult factory.

To clear a fault, issue a STOP command on the terminal strip. The fault will only clear if the condition that caused the fault has passed. For example, if the drive trips on a LOW DC BUS VOLTAGE FAULT (LF) due to low input voltage, the fault cannot be cleared until the input voltage returns to a normal level.

If the drive is programmed to automatically restart after a fault (see Parameter 03), the drive will attempt to restart three times after a fault (the drive will not restart after CF, cF, GF, FC, F1, F2-F9, or Fo faults). If all three restart attempts are unsuccessful, the drive will trip into FAULT LOCKOUT (LC), which requires a manual reset as described above.

17.0 SCL/SCM DISPLAY MESSAGES

The following describes the various displays and messages that can appear on the SCL/SCM drive.

17.1 SPEED DISPLAY

If the drive is in a STOP state (indicated by "- - -" on the display), and the commanded speed is changed, the display will show the commanded speed, and the upper left decimal point will turn on solid. About five seconds after a change is made, the display will begin to alternate between the commanded speed value and the "- - -" display. If the **Mode** button is pressed, the display will stop alternating and show the "- - -" display only.

When the drive is given a START command, the displayed speed will start increasing as the drive accelerates up to the commanded speed. If the commanded speed is changed while the drive is running, the display will show the commanded speed rather than the actual speed, until the actual speed reaches the commanded speed.

If the commanded speed is changed faster than the drive can accelerate or decelerate, the upper left decimal point will blink to indicate that the the drive is accelerating or decelerating to the new speed. Once the actual speed reaches the commanded speed, the upper left decimal point will turn on solid for 5 seconds and then turn off to indicate that the commanded speed has been reached, and that the display is now showing the actual speed.

17.2 CHANGING THE SPEED REFERENCE SOURCE

When the speed source is changed while the drive is running, the display will flash the message for the new speed source to indicate that the new speed source is active. Also, if the drive is being controlled from a speed source other than the ▲ and ▼ buttons (0-10 VDC, 4-20 mA, etc), and one of the ▲ or ▼ buttons is pressed, the display will flash the present speed source message to indicate that the ▲ and ▼ buttons are invalid.

Example 1: The drive is running and the present speed source is the keypad. TB-13A is programmed to select a 4-20 mA signal as the speed source. When TB-13A is closed to TB-11, the display will flash "EI" to indicate that the speed source has changed to the 4-20 mA signal. If the contact between TB-13A and TB-11 is opened, the display will flash "CP" to indicate that the speed source has changed back to the ▲ and ▼ buttons.

Example 2: The speed source is a 0-10 VDC signal. If the ▲ or ▼ button is pushed, the display will flash "EU" to indicate that the present speed source is the 0-10 VDC signal and that the ▲ and ▼ buttons are invalid.

Refer to the table below for the possible speed reference source displays:

SPEED SOURCE DISPLAYS	
DISPLAY	DESCRIPTION
CP	CONTROL PAD: Speed is set using the ▲ and ▼ buttons on the front of the drive.
EI	EXTERNAL CURRENT: Speed is controlled by a 4-20 mA signal wired to TB-25 and TB-2
EU	EXTERNAL VOLTAGE: Speed is controlled by a 0-10 VDC signal wired to TB-5 and TB-2.
JG	JOG: The drive is in Jog mode, and the speed is set by Preset Speed #2 (Parameter 32).
OP	MOP (Motor Operated Pot): Contacts wired to TB-13B and TB-13C are used to increase and decrease the drive speed.
Pr1 - Pr7	PRESET SPEEDS #1-7: Speed is set by the indicated Preset Speed (Parameters 31-37).

NOTE: The speed source displays will flash when the speed reference source is changed while the drive is running to indicate that the new speed reference source is active.

17.3 STATUS AND WARNING MESSAGES

STATUS AND WARNING MESSAGES	
DISPLAY	DESCRIPTION
br	DC BRAKING: The DC braking circuit is activated.
cE	"cE" will be displayed if an EPM with a different parameter version is installed and then an attempt is made to change parameter settings without performing the TRANSLATE function. Refer to PROGRAM SELECTION (Parameter 48).
CL	CURRENT LIMIT: The output current has exceeded the CURRENT LIMIT setting (Parameter 25) and the drive is reducing the output frequency to reduce the output current. If the drive remains in CURRENT LIMIT for too long, it can trip into a CURRENT OVERLOAD fault (PF).
Er	ERROR: Invalid data has been entered or an invalid command was attempted.
GE	"GE" will be displayed if an attempt is made to change the OEM default settings when the drive is operating in the OEM mode (see Parameter 48).
GF	If "GF" is displayed when a RESET OEM is attempted, it indicates that the OEM defaults in the EPM are corrupted. If "GF" is displayed upon power-up, it indicates that the OEM defaults and the user settings in the EPM are corrupted. Refer to Section 13.2.
LC	FAULT LOCKOUT: The drive has failed three restart attempts and now requires manual reset.
SE	SERIAL: The optional remote keypad is active as the user interface instead of the buttons on the front of the drive. See Parameter 14 - CONTROL.
SP	START PENDING: "SP" blinks during the interval between restart attempts.
	DECEL OVERRIDE (both upper decimal points blinking): The drive has stopped decelerating to avoid tripping into an HF fault due to regenerative energy from the motor.

EC DECLARATION OF CONFORMITY

In accordance with EN45014:1998

Applied Council Directive(s): EMC Directive 89/336/EEC, as amended: 92/31/EEC and 93/68/EEC, and Low Voltage Directive 73/23/EEC, as amended: 93/68/EEC

We, Manufacturer:	Authorized Representative:
AC Technology Corporation	AC Technology Europe
630 Douglas Street	6 Park Plaza
Uxbridge, MA 01569 U.S.A.	Battlefield Enterprise Park
	Shrewsbury SY1 3AF U.K.

declare under our sole responsibility that the products to which this Declaration relates, are in conformity with the relevant provisions of the following standards, provided that installations are carried out in accordance with manufacturer's instructions.

PRODUCTS RELATED TO DECLARATION

SCL/SCM Series AC Variable Frequency Motor Drives Models:

SCL	SL204S	SCM	SM004S	SM204S		
Series:	SL205S	Series:	SM005S	SM205S	SM205	SM405
	SL208S			SM208S		
	SL210S		SM010S	SM210S	SM210	SM410
	SL215S		SM015S	SM215S	SM215	SM415
	SL220S			SM220S	SM220	SM420
	SL230S			SM230S	SM230	SM430
					SM250	SM450
					SM275	SM475
					SM2100	SM4100
					SM2150	SM4150

RELEVANT EUROPEAN STANDARDS

EN 61800-3* - Adjustable speed electrical power drive systems, Part 3 - EMC product standard, including specific test methods

EN 50178 - Electronic equipment for use in power installations

* with suitable line filters that are properly installed (SCL models have a built-in filter for this purpose).

YEAR OF CE Marking (Low Voltage Directive): 2001

Signature:

Jim Reinwald, Compliance Manager

Date:

1 October 2001

AC Technology Corporation

630 Douglas Street, Uxbridge MA 01569

Sales: 800-217-9100, FAX: 508-278-7873

Service: 508-278-9100 ext 125, FAX: 508-278-6620

www.actechdrives.com



SM01D